

NEXIT

The new **NEXIT** programme offers a complete range of solutions for any requirement.

Each EURO based dimension of this programme is available in different heights.

Each height offers aesthetic and functional

versions.

Available in the:

200x150 - 300x200 - 400x300 - 600x400 series, heights from:

75 - 120 - 170 - 220 - 270 - 320 - 420 mm.

HANDLES

moulded closed



	H	75	120	170	220	270	320	420
200 x 150	■	■						
200 x 150	■	■						
300 x 200	■	■	■	■				
300 x 200	■	■	■	■				
400 x 300	■	■						
400 x 300	■	■	■	■	■	■		
600 x 400	■	■						
600 x 400	■	■	■	■				

open



	H	75	120	170	220	270	320	420
400 x 300				■	■	■	■	
400 x 300								
600 x 400				■	■	■	■	■
600 x 400						■	■	■



CARTER

1MICUBE

handles closing casing included *

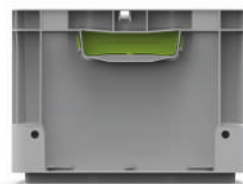

	H	75	120	170	220	270	320	420
400 x 300				■	■	■	■	
400 x 300								
600 x 400				■	■	■	■	■
600 x 400						■	■	■



* supplied assembled

BOTTOMS

closed bottom

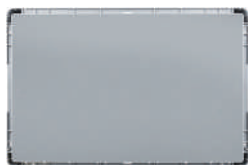

load capacity 20 kg

reinforced bottom

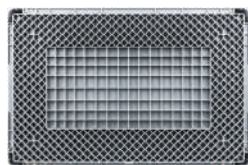

load capacity 50 kg

reinforced perforated bottom

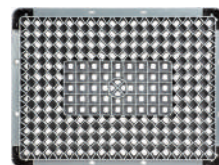

load capacity 50 kg

WALLS

closed walls



perforated walls

only for 400 x 300
and 600 x 400

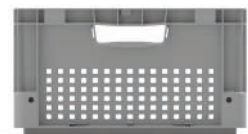

available in heights:
120 - 170 - 220 - 270 - 320 - 420

picking

only for 400 x 300
and 600 x 400



available in heights:
220 - 270 - 320 - 420

ACCESSORIES

separate lid



hinged lid



snap hinged lid

only for 200 x 150
and 300 x 200



2 parts lid

only for 400 x 300
and 600 x 400



	ARTICLE	WALLS		BOTTOM			HANDLES		GR.	PACKAGING		UNIT PRICE €
		Closed	Perforated	Closed	Perforated	Reinforced	Closed	Open		Qty. per pack.	Qty. per pallet	
A	NX 2108A 5101	■		■			■		184	32	1152	
	NX 2108A 5401	■		■			■		192	32	1152	



A

Closed bottom
Load capacity 15 kg



A

Stacked edge height	60 mm
Usable stacked height / with lid	57 mm / 61 mm
Usable internal dimensions	163 x 113 x 72 H mm
Volume	1,4 L
Pieces per package / pallet	📦 32 🚚 1152
Package dimensions	620 x 420 x 290 H mm
Pallet dimensions	1200 x 800 x 2325 H mm

DATASHEET

	ARTICLE	SEPARATE LID	HINGED LID	SNAP HINGED LID	GR.	PACKAGING		UNIT PRICE €	
						Qty. per pack.	Qty. per pallet		
1	NX 21SE 5101	■			72	1	1920		
	NX 21SE 5401	■			75	1	1920		
2	NX 21HG 5101		■		72	1	1920		
	NX 21HG 5401		■		75	1	1920		
3	NX 21HH 5101			■	73	1	1920		
	NX 21HH 5401			■	76	1	1920		
4	NX SEAL23 5113		1x	1x		500			



DATASHEET

Separate lid	200 x 150 mm
1 Pieces per pack.	1
Pieces per pallet / dimens.	1920 / 1200 x 800 x 942 H mm
Hinged lid	200 x 150 mm
2 Pieces per pack.	1
Pieces per pallet / dimens.	1920 / 1200 x 800 x 942 H mm
Snap hinged lid	200 x 150 mm
3 Pieces per pack.	1
Pieces per pallet / dimens.	1920 / 1200 x 800 x 942 H mm
Disposable security seal	
4 Pieces per pack	500

iMilani srl reserves the right to alter the characteristics of products without notice. The values shown are nominal, with a +/- 1% tolerance for size, depending on the material, and a +/- 3% for weight.

200 x 150 mm H 120 mm

ARTICLE	WALLS		BOTTOM			HANDLES		GR.	PACKAGING		UNIT PRICE €
	Closed	Perforated	Closed	Perforated	Reinforced	Closed	Open		Qty. per pack.	Qty. per pallet	
NX 2112A 5101	■		■			■		258	24	672	
NX 2112A 5401	■		■			■		269	24	672	



Closed bottom
Load capacity 15 kg



A



A

Stacked edge height	105 mm
Usable stacked height / with lid	102 mm / 106 mm
Usable internal dimensions	163 x 113 x 117 H mm
Volume	2,3 L
Pieces per package / pallet	📦 24 🚚 672
Package dimensions	620 x 420 x 365 H mm
Pallet dimensions	1200 x 800 x 2370 H mm

DATASHEET

	ARTICLE	SEPARATE LID	HINGED LID	SNAP HINGED LID	GR.	PACKAGING		UNIT PRICE €	
						Qty. per pack.	Qty. per pallet		
1	NX 21SE 5101	■			72	1	1920		
	NX 21SE 5401	■			75	1	1920		
2	NX 21HG 5101		■		72	1	1920		
	NX 21HG 5401		■		75	1	1920		
3	NX 21HH 5101			■	73	1	1920		
	NX 21HH 5401			■	76	1	1920		
4	NX SEAL23 5113		1x	1x		500			



DATASHEET

Separate lid	200 x 150 mm
1 Pieces per pack.	1
Pieces per pallet / dims.	1920 / 1200 x 800 x 942 H mm
Hinged lid	200 x 150 mm
2 Pieces per pack.	1
Pieces per pallet / dims.	1920 / 1200 x 800 x 942 H mm
Snap hinged lid	200 x 150 mm
3 Pieces per pack.	1
Pieces per pallet / dims.	1920 / 1200 x 800 x 942 H mm
Disposable security seal	
4 Pieces per pack	500

300 x 200 mm H 75 mm

ARTICLE	WALLS		BOTTOM			HANDLES		GR.	PACKAGING		UNIT PRICE €
	Closed	Perforated	Closed	Perforated	Reinforced	Closed	Open		Qty. per pack.	Qty. per pallet	
NX 3208A 5101	■		■			■		335	20	560	
NX 3208A 5401	■		■			■		350	20	560	



A

Closed bottom
Load capacity 15 kg



A

Stacked edge height	60 mm
Usable stacked height / with lid	57 mm / 61 mm
Usable internal dimensions	261 x 161 x 72 H mm
Volume	3,2 L
Pieces per package / pallet	📦 20 🚚 560
Package dimensions	620 x 420 x 350 H mm
Pallet dimensions	1200 x 800 x 2325 H mm

DATASHEET

	ARTICLE	SEPARATE LID	HINGED LID	SNAP HINGED LID	GR.	PACKAGING		UNIT PRICE €	
						Qty. per pack.	Qty. per pallet		
1	NX 32SE 5101	■			138	1	1120		
	NX 32SE 5401	■			134	1	1120		
2	NX 32HG 5101		■		136	1	1120		
	NX 32HG 5401		■		142	1	1120		
3	NX 32HH 5101			■	137	1	1120		
	NX 32HH 5401			■	143	1	1120		
4	NX SEAL23 5113		2 x	2 x		500			



1



2



3



4

DATASHEET

Separate lid	300 x 200 mm
1 Pieces per pack.	1
Pieces per pallet / dimens.	1120/1200x800x1072H mm
Hinged lid	300 x 200 mm
2 Pieces per pack.	1
Pieces per pallet / dimens.	1120/1200x800x1072H mm
Snap hinged lid	300 x 200 mm
3 Pieces per pack.	1
Pieces per pallet / dimens.	1120/1200x800x1072H mm
Disposable security seal	
4 Pieces per pack	500

300 x 200 mm H 120 mm

ARTICLE	WALLS		BOTTOM			HANDLES		GR.	PACKAGING		UNIT PRICE €
	Closed	Perforated	Closed	Perforated	Reinforced	Closed	Open		Qty. per pack.	Qty. per pallet	
NX 3212A 5101	■		■			■		450	16	320	
NX 3212A 5401	■		■			■		470	16	320	



A









Closed bottom
Load capacity 15 kg



A

Stacked edge height	105 mm
Usable stacked height / with lid	102 mm / 106 mm
Usable internal dimensions	261 x 161 x 117 H mm
Volume	5,2 L
Pieces per package / pallet	📦 16 🚚 320
Package dimensions	620 x 420 x 470 H mm
Pallet dimensions	1200 x 800 x 2370 H mm

DATASHEET

	ARTICLE	SEPARATE LID	HINGED LID	SNAP HINGED LID	GR.	PACKAGING		UNIT PRICE €	
						Qty. per pack.	Qty. per pallet		
1	NX 32SE 5101	■			138	1	1120		 
	NX 32SE 5401	■			134	1	1120		
2	NX 32HG 5101		■		136	1	1120		 
	NX 32HG 5401		■		142	1	1120		
3	NX 32HH 5101			■	137	1	1120		 
	NX 32HH 5401			■	143	1	1120		
4	NX SEAL23 5113		2 x	2 x		500			 
5	LH TYT	Label holders - for long sides only				10			



1



2



3



4

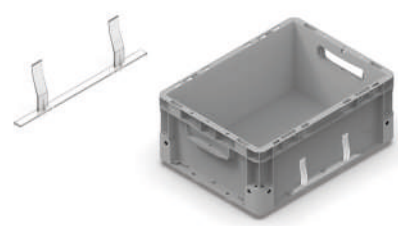

5

DATASHEET

	Separate lid	300 x 200 mm
1	Pieces per pack.	📦 1
	Pieces per pallet / dims.	📦 1120/1200x800x1072H mm
	Hinged lid	300 x 200 mm
2	Pieces per pack.	📦 1
	Pieces per pallet / dims.	📦 1120/1200x800x1072H mm
	Snap hinged lid	300 x 200 mm
3	Pieces per pack.	📦 1
	Pieces per pallet / dims.	📦 1120/1200x800x1072H mm
4	Disposable security seal	
	Pieces per pack	📦 500
5	Label holders	
	Pieces per pack	📦 10

300 x 200 mm H 170 mm

	ARTICLE	WALLS			BOTTOM			HANDLES		GR.	PACKAGING		UNIT PRICE €
		Closed	Perforated		Closed	Perforated	Reinforced	Closed	Open		Qty. per pack.	Qty. per pallet	
A	NX 3217A 5101	■			■			■		552	12	240	
	NX 3217A 5401	■			■			■		576	12	240	



A









Closed bottom
Load capacity 15 kg



A

Stacked edge height	155 mm
Usable stacked height / with lid	152 mm / 156 mm
Usable internal dimensions	261 x 161 x 167 H mm
Volume	7,4 L
Pieces per package / pallet	📦 12 🚚 240
Package dimensions	620 x 420 x 515 H mm
Pallet dimensions	1200 x 800 x 2490 H mm

DATASHEET

	ARTICLE	SEPARATE LID	HINGED LID	SNAP HINGED LID	GR.	PACKAGING		UNIT PRICE €	
						Qty. per pack.	Qty. per pallet		
1	NX 32SE 5101	■			138	1	1120		 
	NX 32SE 5401	■			134	1	1120		
2	NX 32HG 5101		■		136	1	1120		 
	NX 32HG 5401		■		142	1	1120		
3	NX 32HH 5101			■	137	1	1120		 
	NX 32HH 5401			■	143	1	1120		
4	NX SEAL23 5113		2 x	2 x		500			 
5	LH TYT	Label holders - for long sides only				10			



1



2



3





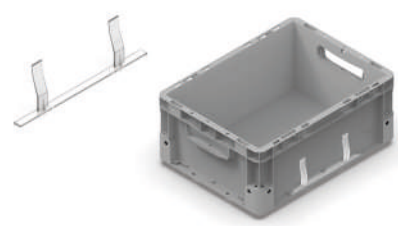





4



5

DATASHEET

Separate lid	300 x 200 mm
1 Pieces per pack.	 1
Pieces per pallet / dimens.	 1120/1200x800x1072H mm
Hinged lid	300 x 200 mm
2 Pieces per pack.	 1
Pieces per pallet / dimens.	 1120/1200x800x1072H mm
Snap hinged lid	300 x 200 mm
3 Pieces per pack.	 1
Pieces per pallet / dimens.	 1120/1200x800x1072H mm
Disposable security seal	
4 Pieces per pack	 500
Label holders	
5 Pieces per pack	 10

ARTICLE	WALLS		BOTTOM			HANDLES		GR.	PACKAGING		UNIT PRICE €
	Closed	Perforated	Closed	Perforated	Reinforced	Closed	Open		Qty. per pack.	Qty. per pallet	
NX 3222A 5101	■		■			■		654	8	160	
NX 3222A 5401	■		■			■		683	8	160	

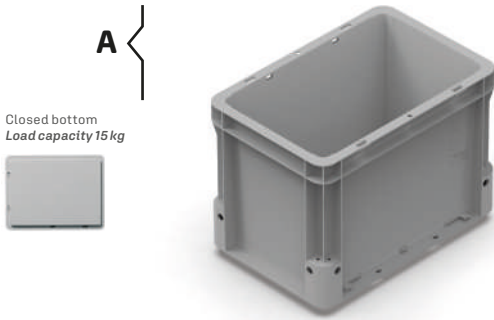

A	
Stacked edge height	205 mm
Usable stacked height / with lid	202 mm / 206 mm
Usable internal dimensions	261 x 161 x 217 H mm
Volume	9,6 L
Pieces per package / pallet	📦 8 🚚 160
Package dimensions	620 x 420 x 460 H mm
Pallet dimensions	1200 x 800 x 2215 H mm

DATASHEET

	ARTICLE	SEPARATE LID	HINGED LID	SNAP HINGED LID	GR.	PACKAGING		UNIT PRICE €	
						Qty. per pack.	Qty. per pallet		
1	NX 32SE 5101	■			138	1	1120		♻️ PP
	NX 32SE 5401	■			134	1	1120		♻️ ECOGREEN PP
2	NX 32HG 5101		■		136	1	1120		♻️ PP
	NX 32HG 5401		■		142	1	1120		♻️ ECOGREEN PP
3	NX 32HH 5101			■	137	1	1120		♻️ PP
	NX 32HH 5401			■	143	1	1120		♻️ ECOGREEN PP
4	NX SEAL23 5113		2 x	2 x		500			♻️ PP
5	LH TYT	Label holders - for long sides only				10			♻️ PP



1



2



3



4

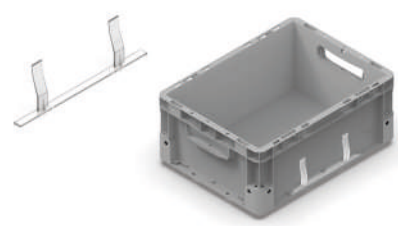

5

DATASHEET

Separate lid	300 x 200 mm
1 Pieces per pack.	📦 1
Pieces per pallet / dimens.	🚚 1120/1200x800x1072H mm
Hinged lid	300 x 200 mm
2 Pieces per pack.	📦 1
Pieces per pallet / dimens.	🚚 1120/1200x800x1072H mm
Snap hinged lid	300 x 200 mm
3 Pieces per pack.	📦 1
Pieces per pallet / dimens.	🚚 1120/1200x800x1072H mm
Disposable security seal	
4 Pieces per pack	📦 500
Label holders	
5 Pieces per pack	📦 10

iMilani srl reserves the right to alter the characteristics of products without notice. The values shown are nominal, with a +/- 1% tolerance for size, depending on the material, and a +/- 3% for weight.

	ARTICLE	WALLS		BOTTOM			HANDLES		GR.	PACKAGING		UNIT PRICE €
		Closed	Perforated	Closed	Perforated	Reinforced	Closed	Open		Qty. per pack.	Qty. per pallet	
 ECOGREEN	A NX 4308A5101	■		■			■		595	14	280	
	A NX 4308A5401	■		■			■		621	14	280	
 ECOGREEN	C NX 4308C5101	■				■	■		810	14	280	
	⚠ ARTICLE ON REQUEST											
 ECOGREEN	C NX 4308C5401	■				■	■		864	14	280	

A

Closed bottom
Load capacity 20 kg

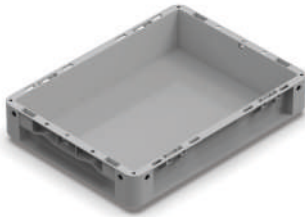

C

Reinforced bottom
Load capacity 50 kg



A

Stacked edge height	60 mm
Usable stacked height / with lid	57 mm / 61 mm
Usable internal dimensions	361 x 261 x 72 H mm
Volume	6,9 L
Pieces per package / pallet	📦 14 🚚 280
Package dimensions	620 x 420 x 470 H mm
Pallet dimensions	1200 x 800 x 2325 H mm









C

Stacked edge height	60 mm
Usable stacked height / with lid	45 mm / 49 mm
Usable internal dimensions	361 x 261 x 60 H mm
Volume	5,8 L
Pieces per package / pallet	📦 14 🚚 280
Package dimensions	620 x 420 x 470 H mm
Pallet dimensions	1200 x 800 x 2325 H mm

DATASHEET

400 x 300 mm

iMICUBE

	ARTICLE	SEPARATE LID	HINGED LID	2 PARTS LID	GR.	PACKAGING		UNIT PRICE €	
						Qty. per pack.	Qty. per pallet		
1	NX 43SE 5101	■			327	1	480		 
	NX 43SE 5401	■			341	1	480		
2	NX 43HG 5101		■		319	1	480		 
	NX 43HG 5401		■		333	1	480		
3	NX 43CR 5101			■	486	1	480		 
	NX 43CR 5401			■	508	1	480		
4	NX SEAL46 5113			2 x		500			 
5	AT LOCK 8113		2 x			10			



1



2



3







4





5

DATASHEET

Separate lid	400 x 300 mm
1 Pieces per pack.	 1
Pieces per pallet / dims.	 480 / 1200x800x870 H mm

Hinged lid	400 x 300 mm
2 Pieces per pack.	 1
Pieces per pallet / dims.	 480 / 1200x800x870 H mm

2-parts lid	400 x 300 mm
3 Pieces per pack.	 1
Pieces per pallet / dtmens.	 480 / 1200x800x870 H mm

Disposable security seal	
4 Pieces per pack	 500

Pair closing clips	
5 Pieces per pack	 10

iMilani srl reserves the right to alter the characteristics of products without notice. The values shown are nominal, with a +/- 1% tolerance for size, depending on the material, and a +/- 3% for weight.

	ARTICLE	WALLS		BOTTOM			HANDLES		GR.	PACKAGING		UNIT PRICE €
		Closed	Perforated	Closed	Perforated	Reinforced	Closed	Open		Qty. per pack.	Qty. per pallet	
♻️ ECO GREEN	A NX 4312A 5101	■		■			■		761	8	160	
	A NX 4312A 5401	■		■			■		794	8	160	
♻️	C NX 4312C 5101	■				■	■		976	8	160	
♻️	P NX 4312P 5101		■		■	■	■		914	8	160	
⚠️	ARTICLE ON REQUEST											
♻️	C NX 4312C 5401	■				■	■		1020	8	160	
♻️	P NX 4312P 5401		■		■	■	■		955	8	160	

A

Closed bottom
Load capacity 20 kg

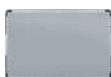

C

Reinforced bottom
Load capacity 50 kg

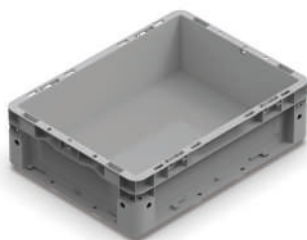

P

Reinforced perforated bottom
Load capacity 50 kg



A	
Stacked edge height	105 mm
Usable stacked height / with lid	102 mm / 106 mm
Usable internal dimensions	361 x 261 x 117 H mm
Volume	11,3 L
Pieces per package / pallet	📦 8 🚚 160
Package dimensions	620 x 420 x 470 H mm
Pallet dimensions	1200 x 800 x 2370 H mm
C	
Stacked edge height	105 mm
Usable stacked height / with lid	90 mm / 94 mm
Usable internal dimensions	361 x 261 x 105 H mm
Volume	10,1 L
Pieces per package / pallet	📦 8 🚚 160
Package dimensions	620 x 420 x 470 H mm
Pallet dimensions	1200 x 800 x 2370 H mm
P	
Stacked edge height	105 mm
Usable stacked height / with lid	90 mm / 94 mm
Usable internal dimensions	361 x 261 x 105 H mm
Volume	10,1 L
Pieces per package / pallet	📦 8 🚚 160
Package dimensions	620 x 420 x 470 H mm
Pallet dimensions	1200 x 800 x 2370 H mm













DATASHEET

iMilani srl reserves the right to alter the characteristics of products without notice. The values shown are nominal, with a +/- 1% tolerance for size, depending on the material, and a +/- 3% for weight.

⚠️ **ARTICLES ON REQUEST**
 Minimum order.....200 boxes
 Guaranteed shipping within.....60 days

400 x 300 mm

iMICUBE

	ARTICLE	SEPARATE LID	HINGED LID	2 PARTS LID	GR.	PACKAGING		UNIT PRICE €	
						Qty. per pack.	Qty. per pallet		
1	NX 43SE 5101	■				327	1 480		 
	NX 43SE 5401	■				341	1 480		
2	NX 43HG 5101		■			319	1 480		 
	NX 43HG 5401		■			333	1 480		
3	NX 43CR 5101			■		486	1 480		 
	NX 43CR 5401			■		508	1 480		
4	NX SEAL46 5113			2 x			500		 
5	AT LOCK 8113		2 x				10		 
6	LH TYT	Label holders for all sides					10		 



1



2



3



4











5



6

DATASHEET

	Separate lid	400 x 300 mm
1	Pieces per pack.	 1
	Pieces per pallet / dimens.	 480 / 1200x800x870 Hmm
	Hinged lid	400 x 300 mm
2	Pieces per pack.	 1
	Pieces per pallet / dimens.	 480 / 1200x800x870 Hmm
	2-parts lid	400 x 300 mm
3	Pieces per pack.	 1
	Pieces per pallet / dimens.	 480 / 1200x800x870 Hmm
	Disposable security seal	
4	Pieces per pack	 10
	Pair closing clips	
5	Pieces per pack	 500
	Label holders	
6	Pieces per pack	 10

iMilani srl reserves the right to alter the characteristics of products without notice. The values shown are nominal, with a +/- 1% tolerance for size, depending on the material, and a +/- 3% for weight.

	ARTICLE	WALLS		BOTTOM			HANDLES		GR.	PACKAGING		UNIT PRICE €
		Closed	Perforated	Closed	Perforated	Reinforced	Closed	Open		Qty. per pack.	Qty. per pallet	
	B NX 4317B 5101	■		■			■		899	6	120	
	A NX 4317A 5401	■		■			■		939	6	120	
	D NX 4317D 5101	■				■	■		1115	6	120	
	S NX 4317S 5101	■			■	■	■		1034	6	120	
	ARTICLE ON REQUEST											
	C NX 4317C 5401	■				■	■		1165	6	120	
	P NX 4317P 5401		■		■	■	■		1081	6	120	

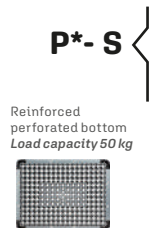
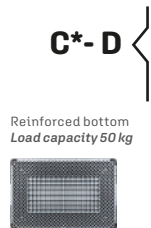
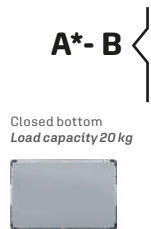

A - B	
Stacked edge height	155 mm
Usable stacked height / with lid	152 mm / 156 mm
Usable internal dimensions	361 x 261 x 167 H mm
Volume	16,1 L
Pieces per package / pallet	6 120
Package dimensions	620 x 420 x 515 H mm
Pallet dimensions	1200 x 800 x 2490 H mm
C - D	
Stacked edge height	155 mm
Usable stacked height / with lid	140 mm / 144 mm
Usable internal dimensions	361 x 261 x 155 H mm
Volume	15 L
Pieces per package / pallet	6 120
Package dimensions	620 x 420 x 515 H mm
Pallet dimensions	1200 x 800 x 2490 H mm
P - S	
Stacked edge height	155 mm
Usable stacked height / with lid	140 mm / 144 mm
Usable internal dimensions	361 x 261 x 155 H mm
Volume	15 L
Pieces per package / pallet	6 120
Package dimensions	620 x 420 x 515 H mm
Pallet dimensions	1200 x 800 x 2490 H mm

DATASHEET

* **ECOGREEN** with closed moulded handle













iMilani srl reserves the right to alter the characteristics of products without notice. The values shown are nominal, with a +/- 1% tolerance for size, depending on the material, and a +/- 3% for weight.

ARTICLES ON REQUEST

Minimum order.....200 boxes
Guaranteed shipping within.....60 days

400 x 300 mm

iMICUBE

	ARTICLE	SEPARATE LID	HINGED LID	2 PARTS LID	GR.	PACKAGING		UNIT PRICE €	
						Qty. per pack.	Qty. per pallet		
1	NX 43SE 5101	■				327	1 480		 
	NX 43SE 5401	■				341	1 480		
2	NX 43HG 5101		■			319	1 480	 	
	NX 43HG 5401		■			333	1 480		
3	NX 43CR 5101			■		486	1 480	 	
	NX 43CR 5401			■		508	1 480		
4	NX SEAL46 5113			2 x			500	 	
5	AT LOCK 8113		2 x				10	 	
6	LH TYT	Label holders for all sides					10	 	



1



2



3



4











5







6





DATASHEET

	Separate lid	400 x 300 mm
1	Pieces per pack.	 1
	Pieces per pallet / dims.	 480 / 1200x800x870 Hmm
	Hinged lid	400 x 300 mm
2	Pieces per pack.	 1
	Pieces per pallet / dims.	 480 / 1200x800x870 Hmm
	2-parts lid	400 x 300 mm
3	Pieces per pack.	 1
	Pieces per pallet / dims.	 480 / 1200x800x870 Hmm
	Disposable security seal	
4	Pieces per pack	 10
	Pair closing clips	
5	Pieces per pack	 500
	Label holders	
6	Pieces per pack	 10

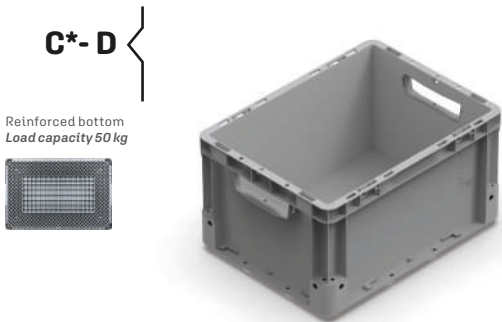
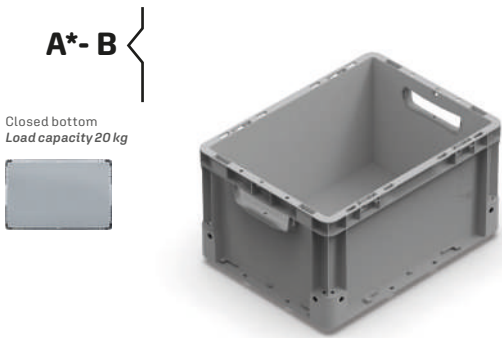
iMilani srl reserves the right to alter the characteristics of products without notice. The values shown are nominal, with a +/- 1% tolerance for size, depending on the material, and a +/- 3% for weight.

	ARTICLE	WALLS		BOTTOM			HANDLES		GR.	PACKAGING		UNIT PRICE €
		Closed	Perforated	Closed	Perforated	Reinforced	Closed	Open		Qty. per pack.	Qty. per pallet	
	B NX 4322B 5101	■		■			■		1146	4	80	
	A NX 4322A 5401	■		■			■		1198	4	80	
	D NX 4322D 5101	■				■	■		1257	4	80	
	ARTICLE ON REQUEST											
	C NX 4322C 5401	■				■	■		1314	4	80	



A - B	
Stacked edge height	205 mm
Usable stacked height / with lid	202 mm / 206 mm
Usable internal dimensions	361 x 261 x 217 H mm
Volume	20,9 L
Pieces per package / pallet	 4  80
Package dimensions	620 x 420 x 460 H mm
Pallet dimensions	1200 x 800 x 2215 H mm
C - D	
Stacked edge height	205 mm
Usable stacked height / with lid	190 mm / 194 mm
Usable internal dimensions	361 x 261 x 205 H mm
Volume	19,8 L
Pieces per package / pallet	 4  80
Package dimensions	620 x 420 x 460 H mm
Pallet dimensions	1200 x 800 x 2215 H mm

DATASHEET

* **ECOGREEN** with closed moulded handle

CONTINUED ON NEXT PAGE















iMilani srl reserves the right to alter the characteristics of products without notice. The values shown are nominal, with a +/- 1% tolerance for size, depending on the material, and a +/- 3% for weight.

 **ARTICLES ON REQUEST**

Minimum order.....200 boxes
Guaranteed shipping within.....60 days

400 x 300 mm

iMICUBE

	ARTICLE	SEPARATE LID	HINGED LID	2 PARTS LID	GR.	PACKAGING		UNIT PRICE €	
						Qty. per pack.	Qty. per pallet		
1	NX 43SE 5101	■				327	1 480		 
	NX 43SE 5401	■				341	1 480		
2	NX 43HG 5101		■			319	1 480		 
	NX 43HG 5401		■			333	1 480		
3	NX 43CR 5101			■		486	1 480		 
	NX 43CR 5401			■		508	1 480		
4	NX SEAL46 5113			2 x			500		 
5	AT LOCK 8113		2 x				10		 
6	LH TYT	Label holders for all sides					10		 



1



2



3



4











5



6

DATASHEET

	Separate lid	400 x 300 mm
1	Pieces per pack.	 1
	Pieces per pallet / dims.	 480 / 1200x800x870 Hmm
	Hinged lid	400 x 300 mm
2	Pieces per pack.	 1
	Pieces per pallet / dims.	 480 / 1200x800x870 Hmm
	2-parts lid	400 x 300 mm
3	Pieces per pack.	 1
	Pieces per pallet / dims.	 480 / 1200x800x870 Hmm
	Disposable security seal	
4	Pieces per pack	 10
	Pair closing clips	
5	Pieces per pack	 500
	Label holders	
6	Pieces per pack	 10

iMilani srl reserves the right to alter the characteristics of products without notice. The values shown are nominal, with a +/- 1% tolerance for size, depending on the material, and a +/- 3% for weight.

	ARTICLE	WALLS			BOTTOM			HANDLES		GR.	PACKAGING		UNIT PRICE €
		Closed	Perforated	Picking short side	Closed	Perforated	Reinforced	Closed	Open		Qty. per pack.	Qty. per pallet	
	S NX 4322S 5101	■				■	■	■		1153	4	80	
	U NX 4322U 5101			■	■				■	1080	4	80	
	ARTICLE ON REQUEST												
	P NX 4322P 5401	■				■	■	■		1205	4	80	
	V NX 4322V 5401			■	■			■		1129	4	80	

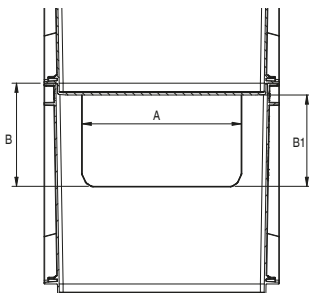
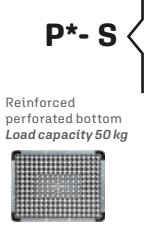

A	202
B	106
B1	91

* **ECOGREEN** with closed moulded handle

◀◀ CONTINUED ON PREVIOUS PAGE

iMilani srl reserves the right to alter the characteristics of products without notice. The values shown are nominal, with a +/- 1% tolerance for size, depending on the material, and a +/- 3% for weight.

P-S

Stacked edge height	205 mm
Usable stacked height / with lid	190 mm / 194 mm
Usable internal dimensions	361 x 261 x 205 H mm
Volume	19,8 L
Pieces per package / pallet	4 80
Package dimensions	620 x 420 x 460 H mm
Pallet dimensions	1200 x 800 x 2215 H mm

V-U

Stacked edge height	205 mm
Usable stacked height / with lid	202 mm / 206 mm
Usable internal dimensions	361 x 261 x 217 H mm
Volume	20,9 L
Pieces per package / pallet	4 80
Package dimensions	620 x 420 x 460 H mm
Pallet dimensions	1200 x 800 x 2215 H mm

DATASHEET

ARTICLES ON REQUEST

Minimum order.....200 boxes
Guaranteed shipping within.....60 days

400 x 300 mm

iMIBUBE

	ARTICLE	SEPARATE LID	HINGED LID	2 PARTS LID	GR.	PACKAGING		UNIT PRICE €	
						Qty. per pack.	Qty. per pallet		
1	NX 43SE 5101	■			327	1	480		
	NX 43SE 5401	■			341	1	480	♻️ ECOGREEN ✓	
2	NX 43HG 5101		■		319	1	480	♻️ PP	
	NX 43HG 5401		■		333	1	480	♻️ ECOGREEN ✓	
3	NX 43CR 5101			■	486	1	480	♻️ PP	
	NX 43CR 5401			■	508	1	480	♻️ ECOGREEN ✓	
4	NX SEAL46 5113			2 x		500		♻️ PP	
5	AT LOCK 8113		2 x			10		♻️ PP	
6	LH TYT	Label holders for all sides				10		♻️ PP	
7	NX WC43326896	H220 Door				1		♻️ PP	



1



2



3



4



5



6



7

DATASHEET

Separate lid	400 x 300 mm
1 Pieces per pack.	📦 1
Pieces per pallet / dimens.	🚚 480 / 1200x800x870 Hmm
Hinged lid	400 x 300 mm
2 Pieces per pack.	📦 1
Pieces per pallet / dimens.	🚚 480 / 1200x800x870 Hmm
2-parts lid	400 x 300 mm
3 Pieces per pack.	📦 1
Pieces per pallet / dimens.	🚚 480 / 1200x800x870 Hmm
Disposable security seal	
4 Pieces per pack	📦 500
Pair closing clips	
5 Pieces per pack	📦 10
Label holders	
6 Pieces per pack	📦 10
H220 Door	
7 Pieces per pack	📦 1

iMilani srl reserves the right to alter the characteristics of products without notice. The values shown are nominal, with a +/- 1% tolerance for size, depending on the material, and a +/- 3% for weight.

	ARTICLE	WALLS		BOTTOM			HANDLES		GR.	PACKAGING		UNIT PRICE €
		Closed	Perforated	Closed	Perforated	Reinforced	Closed	Open		Qty. per pack.	Qty. per pallet	
	B NX 4327B 5101	■		■			■		1186	4	64	
	A NX 4327A 5401	■		■			■		1239	4	64	
	D NX 4327D 5101	■				■	■		1401	4	64	
	ARTICLE ON REQUEST											
	C NX 4327C 5401	■				■	■		1463	4	64	

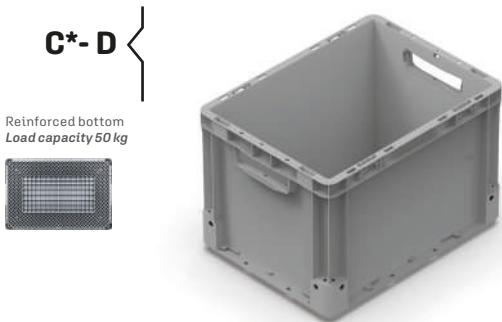
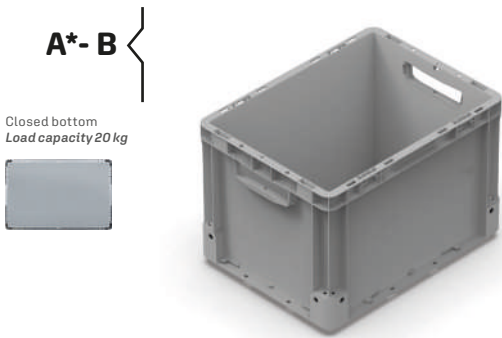

A - B	
Stacked edge height	255 mm
Usable stacked height / with lid	252 mm / 256 mm
Usable internal dimensions	361 x 261 x 267 H mm
Volume	25,8 L
Pieces per package / pallet	4 64
Package dimensions	620 x 420 x 560 H mm
Pallet dimensions	1200 x 800 x 2205 H mm
C - D	
Stacked edge height	255 mm
Usable stacked height / with lid	240 mm / 244 mm
Usable internal dimensions	361 x 261 x 255 H mm
Volume	24,6 L
Pieces per package / pallet	4 64
Package dimensions	620 x 420 x 560 H mm
Pallet dimensions	1200 x 800 x 2205 H mm

DATASHEET

* **ECOGREEN** with closed moulded handle

CONTINUED ON NEXT PAGE















iMilani srl reserves the right to alter the characteristics of products without notice. The values shown are nominal, with a +/- 1% tolerance for size, depending on the material, and a +/- 3% for weight.

ARTICLES ON REQUEST

Minimum order.....200 boxes
Guaranteed shipping within.....60 days

400 x 300 mm

iMICUBE

	ARTICLE	SEPARATE LID	HINGED LID	2 PARTS LID	GR.	PACKAGING		UNIT PRICE €	
						Qty. per pack.	Qty. per pallet		
1	NX 43SE 5101	■				327	1 480		 
	NX 43SE 5401	■				341	1 480		
2	NX 43HG 5101		■			319	1 480		 
	NX 43HG 5401		■			333	1 480		
3	NX 43CR 5101			■		486	1 480		 
	NX 43CR 5401			■		508	1 480		
4	NX SEAL46 5113			2 x			500		 
5	AT LOCK 8113		2 x				10		 
6	LH TYT	Label holders for all sides					10		 



1



2



3



4











5



6

DATASHEET

	Separate lid	400 x 300 mm
1	Pieces per pack.	 1
	Pieces per pallet / dimens.	 480 / 1200x800x870 Hmm
	Hinged lid	400 x 300 mm
2	Pieces per pack.	 1
	Pieces per pallet / dimens.	 480 / 1200x800x870 Hmm
	2-parts lid	400 x 300 mm
3	Pieces per pack.	 1
	Pieces per pallet / dimens.	 480 / 1200x800x870 Hmm
	Disposable security seal	
4	Pieces per pack	 10
	Pair closing clips	
5	Pieces per pack	 500
	Label holders	
6	Pieces per pack	 10

iMilani srl reserves the right to alter the characteristics of products without notice. The values shown are nominal, with a +/- 1% tolerance for size, depending on the material, and a +/- 3% for weight.

	ARTICLE	WALLS			BOTTOM			HANDLES		GR.	PACKAGING		UNIT PRICE €
		Closed	Perforated	Picking short side	Closed	Perforated	Reinforced	Closed	Open		Qty. per pack.	Qty. per pallet	
	S NX 4327S 5101	■				■	■		■	1271	4	64	
	U NX 4327U 5101			■	■				■	1144	4	64	
	ARTICLE ON REQUEST												
	P NX 4327P 5401	■				■	■	■		1328	4	64	
	V NX 4327V 5401			■	■			■		1195	4	64	

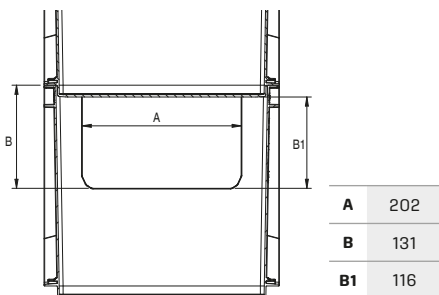
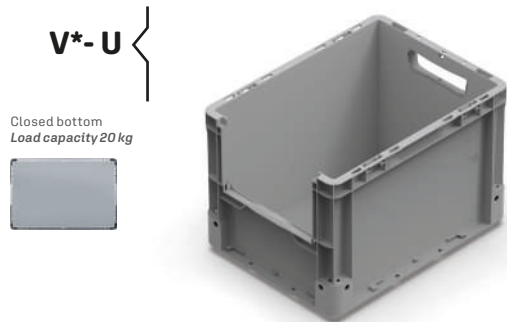
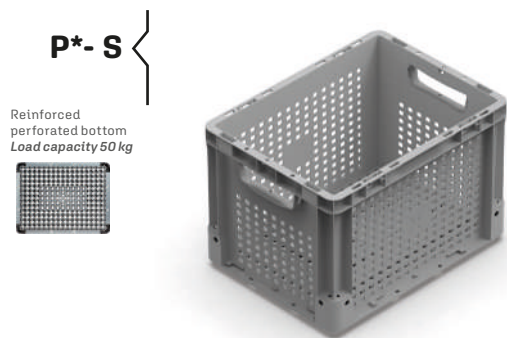

* **ECOGREEN** with closed moulded handle

◀◀ CONTINUED ON PREVIOUS PAGE

iMilani srl reserves the right to alter the characteristics of products without notice. The values shown are nominal, with a +/- 1% tolerance for size, depending on the material, and a +/- 3% for weight.

P-S

Stacked edge height	255 mm
Usable stacked height / with lid	240 mm / 244 mm
Usable internal dimensions	361 x 261 x 255 H mm
Volume	25,8 L
Pieces per package / pallet	4 64
Package dimensions	620 x 420 x 560 H mm
Pallet dimensions	1200 x 800 x 2205 H mm

V-U

Stacked edge height	255 mm
Usable stacked height / with lid	252 mm / 256 mm
Usable internal dimensions	361 x 261 x 267 H mm
Volume	24,6 L
Pieces per package / pallet	4 64
Package dimensions	620 x 420 x 560 H mm
Pallet dimensions	1200 x 800 x 2205 H mm







DATASHEET

ARTICLES ON REQUEST

Minimum order.....200 boxes
Guaranteed shipping within.....60 days

400 x 300 mm

iMICUBE

	ARTICLE	SEPARATE LID	HINGED LID	2 PARTS LID	GR.	PACKAGING		UNIT PRICE €	
						Qty. per pack.	Qty. per pallet		
1	NX 43SE 5101	■			327	1	480		
	NX 43SE 5401	■			341	1	480	ECOGREEN ✓	
2	NX 43HG 5101		■		319	1	480		
	NX 43HG 5401		■		333	1	480	ECOGREEN ✓	
3	NX 43CR 5101			■	486	1	480		
	NX 43CR 5401			■	508	1	480	ECOGREEN ✓	
4	NX SEAL46 5113			2 x		500			
5	AT LOCK 8113		2 x			10			
6	LH TYT	Label holders for all sides				10			
7	NX WC43326896	H270 Door				1			



1



2



3



4



5













6



7

DATASHEET

Separate lid	400 x 300 mm
1 Pieces per pack.	 1
Pieces per pallet / dimens.	 480 / 1200x800x870 Hmm
Hinged lid	400 x 300 mm
2 Pieces per pack.	 1
Pieces per pallet / dimens.	 480 / 1200x800x870 Hmm
2-parts lid	400 x 300 mm
3 Pieces per pack.	 1
Pieces per pallet / dimens.	 480 / 1200x800x870 Hmm
Disposable security seal	
4 Pieces per pack	 500
Pair closing clips	
5 Pieces per pack	 10
Label holders	
6 Pieces per pack	 10
H270 Door	
7 Pieces per pack	 1

iMilani srl reserves the right to alter the characteristics of products without notice. The values shown are nominal, with a +/- 1% tolerance for size, depending on the material, and a +/- 3% for weight.

	ARTICLE	WALLS		BOTTOM			HANDLES		GR.	PACKAGING		UNIT PRICE €
		Closed	Perforated	Closed	Perforated	Reinforced	Closed	Open		Qty. per pack.	Qty. per pallet	
	B NX 4332B 5101	■		■			■		1362	2	56	
	A NX 4332A 5401	■		■			■		1423	2	56	
	D NX 4332D 5101	■				■	■		1577	2	56	
	ARTICLE ON REQUEST											
	C NX 4332C 5401	■				■	■		1648	2	56	

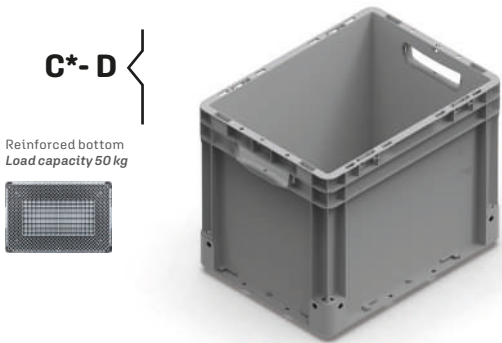
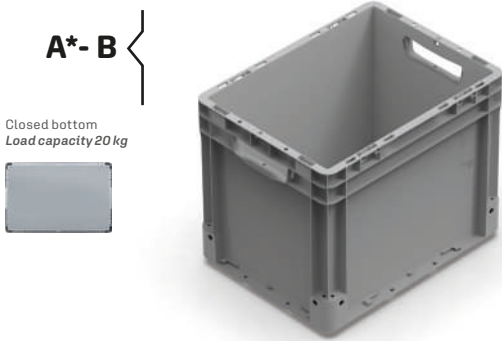

A - B	
Stacked edge height	305 mm
Usable stacked height / with lid	302 mm / 306 mm
Usable internal dimensions	361 x 261 x 317 H mm
Volume	30,6 L
Pieces per package / pallet	2 56
Package dimensions	620 x 420 x 355 H mm
Pallet dimensions	1200 x 800 x 2300 H mm
C - D	
Stacked edge height	305 mm
Usable stacked height / with lid	290 mm / 294 mm
Usable internal dimensions	361 x 261 x 305 H mm
Volume	29,5 L
Pieces per package / pallet	2 56
Package dimensions	620 x 420 x 355 H mm
Pallet dimensions	1200 x 800 x 2300 H mm

DATASHEET

* **ECOGREEN** with closed moulded handle

CONTINUED ON NEXT PAGE















iMilani srl reserves the right to alter the characteristics of products without notice. The values shown are nominal, with a +/- 1% tolerance for size, depending on the material, and a +/- 3% for weight.

ARTICLES ON REQUEST

Minimum order.....200 boxes
Guaranteed shipping within.....60 days

400 x 300 mm

iMICUBE

	ARTICLE	SEPARATE LID	HINGED LID	2 PARTS LID	GR.	PACKAGING		UNIT PRICE €	
						Qty. per pack.	Qty. per pallet		
1	NX 43SE 5101	■				327	1 480		 
	NX 43SE 5401	■				341	1 480		
2	NX 43HG 5101		■			319	1 480		 
	NX 43HG 5401		■			333	1 480		
3	NX 43CR 5101			■		486	1 480		 
	NX 43CR 5401			■		508	1 480		
4	NX SEAL46 5113			2 x			500		 
5	AT LOCK 8113		2 x				10		 
6	LH TYT	Label holders for all sides					10		 



1



2



3



4











5



6

DATASHEET

	Separate lid	400 x 300 mm
1	Pieces per pack.	 1
	Pieces per pallet / dims.	 480 / 1200x800x870 Hmm
	Hinged lid	400 x 300 mm
2	Pieces per pack.	 1
	Pieces per pallet / dims.	 480 / 1200x800x870 Hmm
	2-parts lid	400 x 300 mm
3	Pieces per pack.	 1
	Pieces per pallet / dims.	 480 / 1200x800x870 Hmm
	Disposable security seal	
4	Pieces per pack	 10
	Pair closing clips	
5	Pieces per pack	 500
	Label holders	
6	Pieces per pack	 10

iMilani srl reserves the right to alter the characteristics of products without notice. The values shown are nominal, with a +/- 1% tolerance for size, depending on the material, and a +/- 3% for weight.

	ARTICLE	WALLS			BOTTOM			HANDLES		GR.	PACKAGING		UNIT PRICE €
		Closed	Perforated	Picking short side	Closed	Perforated	Reinforced	Closed	Open		Qty. per pack.	Qty. per pallet	
	S NX 4332S 5101	■			■	■		■		1434	2	56	
	U NX 4332U 5101			■	■			■		1307	2	56	
	ARTICLE ON REQUEST												
	P NX 4332P 5401	■			■	■	■			1499	2	56	
	V NX 4332V 5401			■	■			■		1366	2	56	

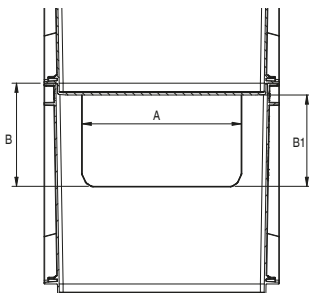
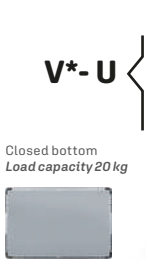
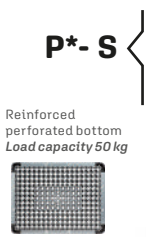

A	202
B	156
B1	141

* **ECOGREEN** with closed moulded handle

◀◀ CONTINUED ON PREVIOUS PAGE

iMilani srl reserves the right to alter the characteristics of products without notice. The values shown are nominal, with a +/- 1% tolerance for size, depending on the material, and a +/- 3% for weight.

P-S

Stacked edge height	305 mm
Usable stacked height / with lid	290 mm / 294 mm
Usable internal dimensions	361 x 261 x 305 H mm
Volume	29,5 L
Pieces per package / pallet	2 56
Package dimensions	620 x 420 x 355 H mm
Pallet dimensions	1200 x 800 x 2300 H mm

V-U

Stacked edge height	305 mm
Usable stacked height / with lid	302 mm / 306 mm
Usable internal dimensions	361 x 261 x 317 H mm
Volume	30,6 L
Pieces per package / pallet	2 56
Package dimensions	620 x 420 x 355 H mm
Pallet dimensions	1200 x 800 x 2300 H mm











DATASHEET

ARTICLES ON REQUEST

Minimum order.....200 boxes
Guaranteed shipping within.....60 days

400 x 300 mm

iMICUBE

	ARTICLE	SEPARATE LID	HINGED LID	2 PARTS LID	GR.	PACKAGING		UNIT PRICE €	
						Qty. per pack.	Qty. per pallet		
1	NX 43SE 5101	■			327	1	480		
	NX 43SE 5401	■			341	1	480		
2	NX 43HG 5101		■		319	1	480		
	NX 43HG 5401		■		333	1	480		
3	NX 43CR 5101			■	486	1	480		
	NX 43CR 5401			■	508	1	480		
4	NX SEAL46 5113			2 x		500			
5	AT LOCK 8113		2 x			10			
6	LH TYT	Label holders for all sides				10			
7	NX WC43326896	H320 Door				1			



1



2



3



4



5

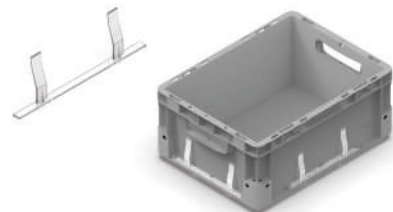

6



7

DATASHEET

	Separate lid	400 x 300 mm
1	Pieces per pack.	📦 1
	Pieces per pallet / dims.	🚚 480 / 1200x800x870 Hmm
	Hinged lid	400 x 300 mm
2	Pieces per pack.	📦 1
	Pieces per pallet / dims.	🚚 480 / 1200x800x870 Hmm
	2-parts lid	400 x 300 mm
3	Pieces per pack.	📦 1
	Pieces per pallet / dims.	🚚 480 / 1200x800x870 Hmm
4	Disposable security seal	
	Pieces per pack	📦 500
5	Pair closing clips	
	Pieces per pack	📦 10
6	Label holders	
	Pieces per pack	📦 10
7	H320 Door	
	Pieces per pack	📦 1

iMilani srl reserves the right to alter the characteristics of products without notice. The values shown are nominal, with a +/- 1% tolerance for size, depending on the material, and a +/- 3% for weight.

ARTICLE	1 PARTITION	2 PARTITIONS	4 PARTITIONS	GR.	PACKAGING		UNIT PRICE €
					Qty. per pack.	Qty. per pallet	
ECOGREEN ✓ 1 AT 43S1 5407	■			230	20	320	
ECOGREEN ✓ 2 AT 43S2 5407		■		246	20	320	
ECOGREEN ✓ 3 AT 43S4 5407			■	272	20	320	
4 AT LID4 6896	Transparent lid			118	20		

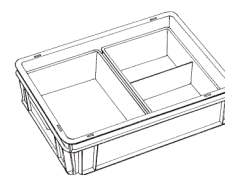
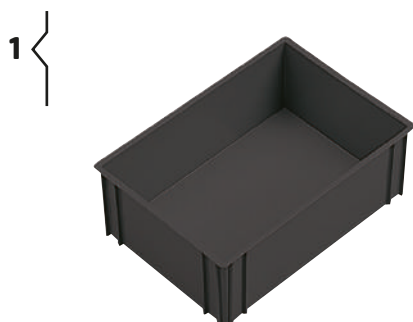

Subdivision with 1 and 2 compartments

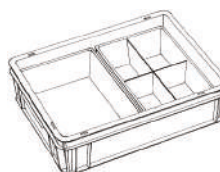
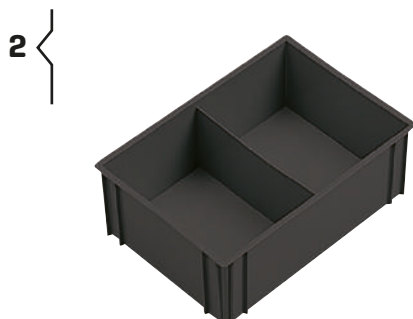

Subdivision with 1 and 4 compartments



Subdivision with 2 and 4 compartments

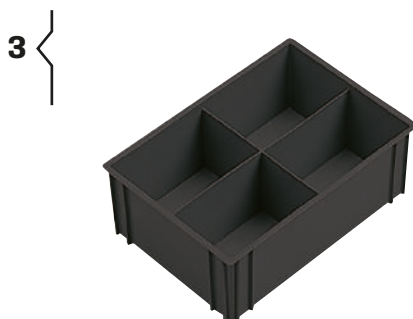

1	
Partitioned box 1 partition	256 x 178 x 90 H mm
Pieces per pack / pallet	📦 20 🚚 320
Package dimensions	565 x 375 x 460 H mm
Pallet dimensions	1200 x 800 x 1990 H mm
2	
Partitioned box 2 partitions	256 x 178 x 90 H mm
Pieces per pack / pallet	📦 20 🚚 320
Package dimensions	565 x 375 x 460 H mm
Pallet dimensions	1200 x 800 x 1990 H mm
3	
Partitioned box 4 partitions	256 x 178 x 90 H mm
Pieces per pack / pallet	📦 20 🚚 320
Package dimensions	565 x 375 x 460 H mm
Pallet dimensions	1200 x 800 x 1990 H mm
4	
Transparent polystyrene lid	
Pieces per pack	📦 20
Package dimensions	265 x 195 x 180 H mm

400 x 300 mm

	ARTICLE	H 45	H 70	H 90	H 120	H 180	H 220	PACKAGING		UNIT PRICE €
								Qty. per pack.	Qty. per pallet	
1	DI 25545246801	■						10		PS
	DI 35545246801	■						10		
2	DI 25570246801		■					10		PS
	DI 35570246801		■					10		
3	DI 25590246801			■				10		PS
	DI 35590246801			■				10		
4	DI 25512246801				■			10		PS
	DI 35512246801				■			10		
5	DI 25518246801					■		10		PS
	DI 35518246801					■		10		
6	DI 25522246801						■	10		PS
	DI 35522246801						■	10		
7	DI 43SHT 5101							10		PS

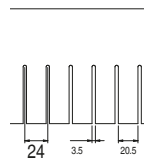

6801

Pitch 24 mm

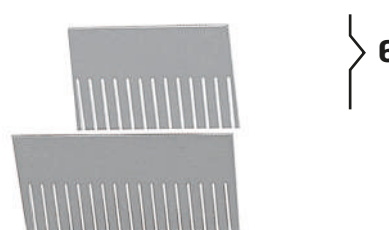
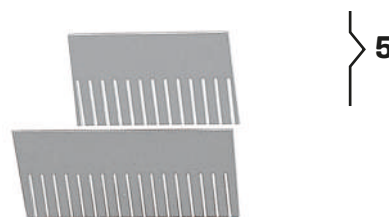
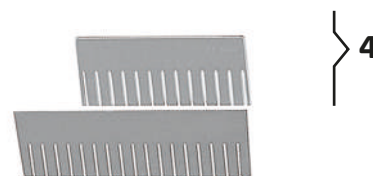
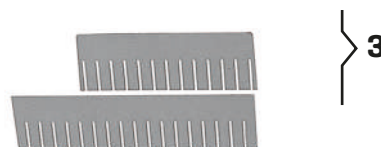

DATASHEET

1	Comb divider 255 x 45 H mm per box 400 x 300 x 75 H mm	10 items
	Séparateur type peigne 355 x H 45 mm per box 400 x 300 x H 75 mm	10 items
2	Comb divider 255 x 70 H mm per box 400 x 300 x 120 H mm	10 items
	Comb divider 355 x 70 H mm per box 400 x 300 x 120 H mm	10 items
3	Comb divider 255 x 90 H mm per box 400 x 300 x 120 H mm	10 items
	Comb divider 355 x 90 H mm per box 400 x 300 x 120 H mm	10 items
4	Comb divider 255 x 120 H mm per box 400 x 300 x 170 H mm	10 items
	Comb divider 355 x 120 H mm per box 400 x 300 x 170 H mm	10 items
5	Comb divider 255 x 180 H mm per box 400 x 300 x 220 H mm	10 items
	Comb divider 355 x 180 H mm per box 400 x 300 x 220 H mm	10 items
6	Comb divider 255 x 220 H mm per box 400 x 300 x 270 H mm	10 items
	Comb divider 355 x 220 H mm per box 400 x 300 x 270 H mm	10 items
7	Intermediate partition shelf 355 x 255 mm	10 items

600 x 400 mm H 75 mm

	ARTICLE	WALLS		BOTTOM			HANDLES		GR.	PACKAGING		UNIT PRICE €
		Closed	Perforated	Closed	Perforated	Reinforced	Closed	Open		Qty. per pack.	Qty. per pallet	
♻️ ECO GREEN	A NX 6408A5101	■		■			■		1178	7	140	
	A NX 6408A5401	■		■			■		1231	7	140	
♻️	C NX 6408C5101	■				■	■		1699	7	140	
♻️	P NX 6408P5101		■		■	■	■		1604	7	140	
⚠️	ARTICLE ON REQUEST											
♻️	C NX 6408C5401	■				■	■		1775	7	140	
♻️	P NX 6408P5401		■		■	■	■		1676	7	140	

A

Closed bottom
Load capacity 20 kg



C

Reinforced bottom
Load capacity 50 kg



P

Reinforced perforated bottom
Load capacity 50 kg

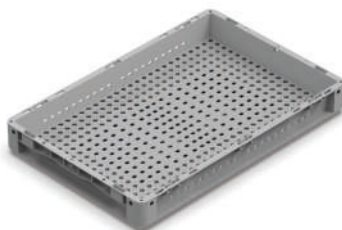

A

Stacked edge height	60 mm
Usable stacked height / with lid	57 mm / 61 mm
Usable internal dimensions	561 x 361 x 72 H mm
Volume	14,7 L
Pieces per package / pallet	📦 7 🚚 140
Package dimensions	620 x 420 x 470 H mm
Pallet dimensions	1200 x 800 x 2325 H mm

C

Stacked edge height	60 mm
Usable stacked height / with lid	45 mm / 49 mm
Usable internal dimensions	561 x 361 x 60 H mm
Volume	11,8 L
Pieces per package / pallet	📦 7 🚚 140
Package dimensions	620 x 420 x 470 H mm
Pallet dimensions	1200 x 800 x 2325 H mm

P

Stacked edge height	60 mm
Usable stacked height / with lid	45 mm / 49 mm
Usable internal dimensions	561 x 361 x 60 H mm
Volume	11,8 L
Pieces per package / pallet	📦 7 🚚 140
Package dimensions	620 x 420 x 470 H mm
Pallet dimensions	1200 x 800 x 2325 H mm

DATASHEET

iMilani srl reserves the right to alter the characteristics of products without notice. The values shown are nominal, with a +/- 1% tolerance for size, depending on the material, and a +/- 3% for weight.

⚠️ ARTICLES ON REQUEST

Minimum order.....200 boxes
Guaranteed shipping within.....60 days

	ARTICLE	SEPARATE LID	HINGED LID	2 PARTS LID	GR.	PACKAGING		UNIT PRICE €	
						Qty. per pack.	Qty. per pallet		
1	NX 64SE 5101	■			751	1	176		♻️
	NX 64SE 5401	■			785	1	176	♻️ ECOGREEN	
2	NX 64HG 5101		■		710	1	176		♻️
	NX 64HG 5401		■		742	1	176	♻️ ECOGREEN	
3	NX 64CR 5101			■	1016	1	176		♻️
	NX 64CR 5401			■	1062	1	176	♻️ ECOGREEN	
4	NX 64CV 5101	Cover			845	1	176		♻️
	NX 64CV 5401	Cover			883	1	176	♻️ ECOGREEN	
5	NX SEAL46 5113			2 x		500			♻️
6	AT LOCK 8113		2 x			10			♻️



1



2



3



4



5



6

DATASHEET

Separate lid	600 x 400 mm
1 Pieces per pack.	📦 1
Pieces per pallet / dims.	📦 176 / 1200x800x870 H mm
Hinged lid	600 x 400 mm
2 Pieces per pack.	📦 1
Pieces per pallet / dims.	📦 176 / 1200x800x870 H mm
2-parts lid	600 x 400 mm
3 Pieces per pack.	📦 1
Pieces per pallet / dims.	📦 176 / 1200x800x870 H mm
Cover	600 x 400 mm
4 Pieces per pack.	📦 1
Pieces per pallet / dims.	📦 176 / 1200x800x870 H mm
Disposable security seal	
5 Pieces per pack	📦 500
Pair closing clips	
6 Pieces per pack	📦 10

	ARTICLE	WALLS		BOTTOM			HANDLES		GR.	PACKAGING		UNIT PRICE €
		Closed	Perforated	Closed	Perforated	Reinforced	Closed	Open		Qty. per pack.	Qty. per pallet	
♻️ ECO GREEN	A NX 6412A 5101	■		■			■		1441	4	80	
	A NX 6412A 5401	■		■			■		1506	4	80	
♻️	C NX 6412C 5101	■				■	■		1961	4	80	
♻️	P NX 6412P 5101		■		■	■	■		1828	4	80	
⚠️ ARTICLE ON REQUEST												
♻️	C NX 6412C 5401	■				■	■		2049	4	80	
♻️	P NX 6412P 5401		■		■	■	■		1910	4	80	

A

Closed bottom
Load capacity 20 kg



C

Reinforced bottom
Load capacity 50 kg



P

Reinforced perforated bottom
Load capacity 50 kg



A

Stacked edge height	105 mm
Usable stacked height / with lid	102 mm / 106 mm
Usable internal dimensions	561 x 361 x 117 H mm
Volume	23,9 L
Pieces per package / pallet	📦 4 🚚 80
Package dimensions	620 x 420 x 470 H mm
Pallet dimensions	1200 x 800 x 2370 H mm







C

Stacked edge height	105 mm
Usable stacked height / with lid	90 mm / 94 mm
Usable internal dimensions	561 x 361 x 105 H mm
Volume	21,1 L
Pieces per package / pallet	📦 4 🚚 80
Package dimensions	620 x 420 x 470 H mm
Pallet dimensions	1200 x 800 x 2370 H mm

P

Stacked edge height	105 mm
Usable stacked height / with lid	90 mm / 94 mm
Usable internal dimensions	561 x 361 x 105 H mm
Volume	21,1 L
Pieces per package / pallet	📦 4 🚚 80
Package dimensions	620 x 420 x 470 H mm
Pallet dimensions	1200 x 800 x 2370 H mm

DATASHEET

	ARTICLE	SEPARATE LID	HINGED LID	2 PARTS LID	GR.	PACKAGING		UNIT PRICE €	
						Qty. per pack.	Qty. per pallet		
1	NX 64SE 5101	■			751	1	176		
	NX 64SE 5401	■			785	1	176	ECOGREEN ✓	
2	NX 64HG 5101		■		710	1	176		
	NX 64HG 5401		■		742	1	176	ECOGREEN ✓	
3	NX 64CR 5101			■	1016	1	176		
	NX 64CR 5401			■	1062	1	176	ECOGREEN ✓	
4	NX 64CV 5101	Cover			845	1	176		
	NX 64CV 5401	Cover			883	1	176	ECOGREEN ✓	
5	NX SEAL46 5113			2 x		500			
6	AT LOCK 8113		2 x			10			
7	LH TYT	Label holders for all sides				10			



1



2



3



4



5



6



7

DATASHEET

Separate lid	600 x 400 mm
1 Pieces per pack.	1
Pieces per pallet / dimens.	176 / 1200x800x870H mm
Hinged lid	600 x 400 mm
2 Pieces per pack.	1
Pieces per pallet / dtmens.	176 / 1200x800x870H mm
2-parts lid	600 x 400 mm
3 Pieces per pack.	1
Pieces per pallet / dimens.	176 / 1200x800x870H mm
Cover	600 x 400 mm
4 Pieces per pack.	1
Pieces per pallet / dimens.	176 / 1200x800x870H mm
Disposable security seal	
5 Pieces per pack	500
Pair closing clips	
6 Pieces per pack	10
Label holders	
7 Pieces per pack	10

	ARTICLE	WALLS		BOTTOM			HANDLES		GR.	PACKAGING		UNIT PRICE €
		Closed	Perforated	Closed	Perforated	Reinforced	Closed	Open		Qty. per pack.	Qty. per pallet	
	B NX 6417B 5101	■		■			■		1680	3	60	
	A NX 6417A 5401	■		■			■		1756	3	60	
	D NX 6417D 5101	■				■		■	2191	3	60	
	S NX 6417S 5101		■		■	■		■	2022	3	60	
	ARTICLE ON REQUEST											
	C NX 6417C 5401	■				■	■		2290	3	60	
	P NX 6417P 5401		■		■	■	■		2113	3	60	

Closed bottom
Load capacity 20 kg



A* - B

Reinforced bottom
Load capacity 50 kg

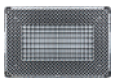

C* - D

Reinforced perforated bottom
Load capacity 50 kg



P* - S

A - B

Stacked edge height	155 mm
Usable stacked height / with lid	152 mm / 156 mm
Usable internal dimensions	561 x 361 x 167 H mm
Volume	34,2 L
Pieces per package / pallet	3 60
Package dimensions	620 x 420 x 515 H mm
Pallet dimensions	1200 x 800 x 2490 H mm

C - D

Stacked edge height	155 mm
Usable stacked height / with lid	140 mm / 144 mm
Usable internal dimensions	561 x 361 x 155 H mm
Volume	31,4 L
Pieces per package / pallet	3 60
Package dimensions	620 x 420 x 515 H mm
Pallet dimensions	1200 x 800 x 2490 H mm

P - S

Stacked edge height	155 mm
Usable stacked height / with lid	140 mm / 144 mm
Usable internal dimensions	561 x 361 x 155 H mm
Volume	31,4 L
Pieces per package / pallet	3 60
Package dimensions	620 x 420 x 515 H mm
Pallet dimensions	1200 x 800 x 2490 H mm







DATASHEET

* **ECOGREEN** with closed moulded handle

iMilani srl reserves the right to alter the characteristics of products without notice. The values shown are nominal, with a +/- 1% tolerance for size, depending on the material, and a +/- 3% for weight.

ARTICLES ON REQUEST

Minimum order.....200 boxes
Guaranteed shipping within.....60 days

	ARTICLE	SEPARATE LID	HINGED LID	2 PARTS LID	GR.	PACKAGING		UNIT PRICE €	
						Qty. per pack.	Qty. per pallet		
1	NX 64SE 5101	■			751	1	176		
	NX 64SE 5401	■			785	1	176	ECOGREEN ✓	
2	NX 64HG 5101		■		710	1	176		
	NX 64HG 5401		■		742	1	176	ECOGREEN ✓	
3	NX 64CR 5101			■	1016	1	176		
	NX 64CR 5401			■	1062	1	176	ECOGREEN ✓	
4	NX 64CV 5101	Cover			845	1	176		
	NX 64CV 5401				883	1	176	ECOGREEN ✓	
5	NX SEAL46 5113			2 x		500			
6	AT LOCK 8113		2 x			10			
7	LH TYT	Label holders for all sides				10			



1



2



3



4



5



6



7

DATASHEET

Separate lid	600 x 400 mm
1 Pieces per pack.	📦 1
Pieces per pallet / dimens.	🚚 176 / 1200x800x870H mm
Hinged lid	600 x 400 mm
2 Pieces per pack.	📦 1
Pieces per pallet / dtmens.	🚚 176 / 1200x800x870H mm
2-parts lid	600 x 400 mm
3 Pieces per pack.	📦 1
Pieces per pallet / dimens.	🚚 176 / 1200x800x870H mm
Cover	600 x 400 mm
4 Pieces per pack.	📦 1
Pieces per pallet / dimens.	🚚 176 / 1200x800x870H mm
Disposable security seal	
5 Pieces per pack	📦 500
Pair closing clips	
6 Pieces per pack	📦 10
Label holders	
7 Pieces per pack	📦 10

600 x 400 mm H 220 mm

	ARTICLE	WALLS		BOTTOM			HANDLES		GR.	PACKAGING		UNIT PRICE €
		Closed	Perforated	Closed	Perforated	Reinforced	Closed	Open		Qty. per pack.	Qty. per pallet	
	B NX 6422B 5101	■		■			■		1901	2	40	
	A NX 6422A 5401	■		■			■		1987	2	40	
	D NX 6422D 5101	■				■	■		2421	2	40	
	ARTICLE ON REQUEST											
	C NX 6422C 5401	■				■	■		2530	2	40	

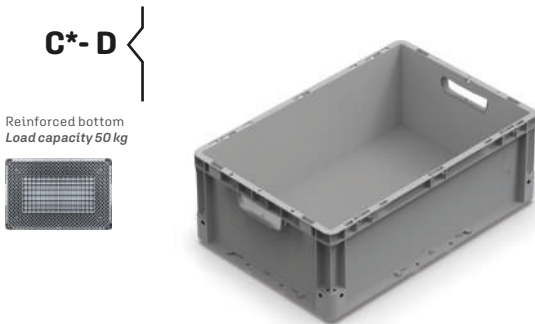
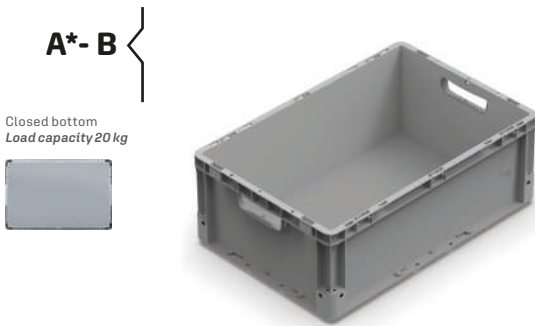

A - B	
Stacked edge height	205 mm
Usable stacked height / with lid	202 mm / 206 mm
Usable internal dimensions	561 x 361 x 217 H mm
Volume	44,5 L
Pieces per package / pallet	2 40
Package dimensions	620 x 420 x 460 H mm
Pallet dimensions	1200 x 800 x 2215 H mm
C - D	
Stacked edge height	205 mm
Usable stacked height / with lid	190 mm / 194 mm
Usable internal dimensions	561 x 361 x 205 H mm
Volume	41,7 L
Pieces per package / pallet	2 40
Package dimensions	620 x 420 x 460 H mm
Pallet dimensions	1200 x 800 x 2215 H mm

DATASHEET

* **ECOGREEN** with closed moulded handle







CONTINUED ON NEXT PAGE



iMilani srl reserves the right to alter the characteristics of products without notice. The values shown are nominal, with a +/- 1% tolerance for size, depending on the material, and a +/- 3% for weight.

ARTICLES ON REQUEST

Minimum order.....200 boxes
Guaranteed shipping within.....60 days

	ARTICLE	SEPARATE LID	HINGED LID	2 PARTS LID	GR.	PACKAGING		UNIT PRICE €	
						Qty. per pack.	Qty. per pallet		
1	NX 64SE 5101	■			751	1	176		
	NX 64SE 5401	■			785	1	176	ECOGREEN ✓	
2	NX 64HG 5101		■		710	1	176		
	NX 64HG 5401		■		742	1	176	ECOGREEN ✓	
3	NX 64CR 5101			■	1016	1	176		
	NX 64CR 5401			■	1062	1	176	ECOGREEN ✓	
4	NX 64CV 5101	Cover			845	1	176		
	NX 64CV 5401				883	1	176	ECOGREEN ✓	
5	NX SEAL46 5113			2 x		500			
6	AT LOCK 8113		2 x			10			
7	LH TYT	Label holders for all sides				10			



1



2



3



4



5



6



7

DATASHEET

Separate lid	600 x 400 mm
1 Pieces per pack.	📦 1
Pieces per pallet / dimens.	📦 176 / 1200x800x870H mm
Hinged lid	600 x 400 mm
2 Pieces per pack.	📦 1
Pieces per pallet / dtmens.	📦 176 / 1200x800x870H mm
2-parts lid	600 x 400 mm
3 Pieces per pack.	📦 1
Pieces per pallet / dimens.	📦 176 / 1200x800x870H mm
Cover	600 x 400 mm
4 Pieces per pack.	📦 1
Pieces per pallet / dimens.	📦 176 / 1200x800x870H mm
Disposable security seal	
5 Pieces per pack	📦 500
Pair closing clips	
6 Pieces per pack	📦 10
Label holders	
7 Pieces per pack	📦 10

	ARTICLE	WALLS			BOTTOM			HANDLES		GR.	PACKAGING		UNIT PRICE €
		Closed	Perforated	Picking short side	Closed	Perforated	Reinforced	Closed	Open		Qty. per pack.	Qty. per pallet	
	S NX 6422S 5101	■				■	■	■		2164	2	40	
	U NX 6422U 5101			■	■				■	1838	2	40	
	ARTICLE ON REQUEST												
	P NX 6422P 5401	■				■	■	■		2261	2	40	
	V NX 6422V 5401			■	■			■		1921	2	40	

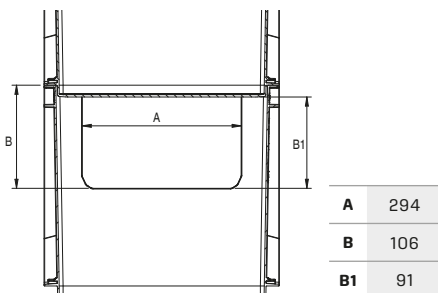
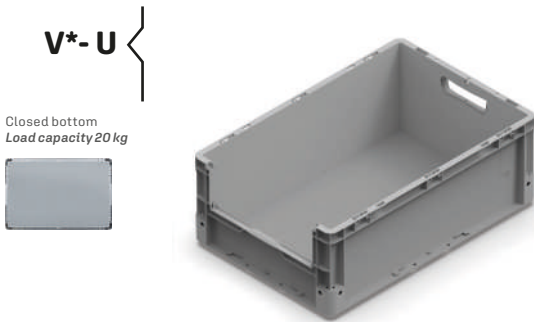
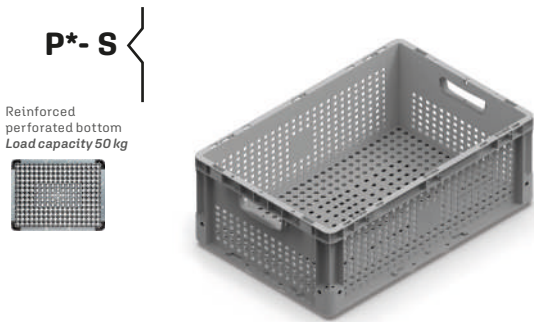

* **ECOGREEN** with closed moulded handle

◀ CONTINUED ON PREVIOUS PAGE

iMilani srl reserves the right to alter the characteristics of products without notice. The values shown are nominal, with a +/- 1% tolerance for size, depending on the material, and a +/- 3% for weight.

P - S

Stacked edge height	205 mm
Usable stacked height / with lid	190 mm / 194 mm
Usable internal dimensions	561 x 361 x 205 H mm
Volume	41,7 L
Pieces per package / pallet	2 40
Package dimensions	620 x 420 x 460 H mm
Pallet dimensions	1200 x 800 x 2215 H mm

V - U

Stacked edge height	205 mm
Usable stacked height / with lid	202 mm / 206 mm
Usable internal dimensions	561 x 361 x 217 H mm
Volume	44,5 L
Pieces per package / pallet	2 40
Package dimensions	620 x 420 x 460 H mm
Pallet dimensions	1200 x 800 x 2215 H mm

DATASHEET

ARTICLES ON REQUEST

Minimum order.....200 boxes
Guaranteed shipping within.....60 days

600 x 400 mm

iMICUBE

	ARTICLE	SEPARATE LID	HINGED LID	2 PARTS LID	GR.	PACKAGING		UNIT PRICE €	
						Qty. per pack.	Qty. per pallet		
1	NX 64SE 5101	■			751	1	176		
	NX 64SE 5401	■			785	1	176	ECOGREEN ✓	
2	NX 64HG 5101		■		710	1	176		
	NX 64HG 5401		■		742	1	176	ECOGREEN ✓	
3	NX 64CR 5101			■	1016	1	176		
	NX 64CR 5401			■	1062	1	176	ECOGREEN ✓	
4	NX 64CV 5101	Cover			845	1	176		
	NX 64CV 5401				883	1	176	ECOGREEN ✓	
5	NX SEAL46 5113			2 x			500		
6	AT LOCK 8113		2 x				10		
7	LH TYT	Label holders for all sides					10		
8	NX WC64226896	Door for H220					10		



1



2



3



4



5



6



7



8

DATASHEET

Separate lid	600 x 400 mm
1 Pieces per pack.	1
Pieces per pallet / dims.	176 / 1200x800x870H mm
Hinged lid	600 x 400 mm
2 Pieces per pack.	1
Pieces per pallet / dims.	176 / 1200x800x870H mm
2-parts lid	600 x 400 mm
3 Pieces per pack.	1
Pieces per pallet / dims.	176 / 1200x800x870H mm
Cover	600 x 400 mm
4 Pieces per pack.	1
Pieces per pallet / dims.	176 / 1200x800x870H mm
Disposable security seal	
5 Pieces per pack	500
Pair closing clips	
6 Pieces per pack	10
Label holders	
7 Pieces per pack	10
Door for H220	
8 Pieces per pack	1

iMilani srl reserves the right to alter the characteristics of products without notice. The values shown are nominal, with a +/- 1% tolerance for size, depending on the material, and a +/- 3% for weight.

	ARTICLE	WALLS		BOTTOM			HANDLES		GR.	PACKAGING		UNIT PRICE €
		Closed	Perforated	Closed	Perforated	Reinforced	Closed	Open		Qty. per pack.	Qty. per pallet	
♻️ B ECOGREEN	NX 6427B 5101	■		■			■		2133	2	32	
	NX 6427B 5401	■		■			■		2229	2	32	
♻️ D	NX 6427D 5101	■				■		■	2654	2	32	
⚠️	ARTICLE ON REQUEST											
♻️ D	NX 6427D 5401	■				■	■		2773	2	32	

Closed bottom
Load capacity 20 kg



B



Reinforced bottom
Load capacity 50 kg



D



B

Stacked edge height	255 mm
Usable stacked height / with lid	252 mm / 256 mm
Usable internal dimensions	561 x 361 x 267 H mm
Volume	54,8 L
Pieces per package / pallet	📦 2 🚚 32
Package dimensions	620 x 420 x 560 H mm
Pallet dimensions	1200 x 800 x 2205 H mm

D

Stacked edge height	255 mm
Usable stacked height / with lid	240 mm / 244 mm
Usable internal dimensions	561 x 361 x 255 H mm
Volume	52 L
Pieces per package / pallet	📦 2 🚚 32
Package dimensions	620 x 420 x 560 H mm
Pallet dimensions	1200 x 800 x 2205 H mm

DATASHEET







CONTINUED ON NEXT PAGE



iMilani srl reserves the right to alter the characteristics of products without notice. The values shown are nominal, with a +/- 1% tolerance for size, depending on the material, and a +/- 3% for weight.

⚠️ ARTICLES ON REQUEST

Minimum order.....200 boxes
Guaranteed shipping within.....60 days

	ARTICLE	SEPARATE LID	HINGED LID	2 PARTS LID	GR.	PACKAGING		UNIT PRICE €	
						Qty. per pack.	Qty. per pallet		
1	NX 64SE 5101	■			751	1	176		
	NX 64SE 5401	■			785	1	176	ECOGREEN ✓	
2	NX 64HG 5101		■		710	1	176		
	NX 64HG 5401		■		742	1	176	ECOGREEN ✓	
3	NX 64CR 5101			■	1016	1	176		
	NX 64CR 5401			■	1062	1	176	ECOGREEN ✓	
4	NX 64CV 5101	Cover			845	1	176		
	NX 64CV 5401	Cover			883	1	176	ECOGREEN ✓	
5	NX SEAL46 5113			2 x		500			
6	AT LOCK 8113		2 x			10			
7	LH TYT	Label holders for all sides				10			



1



2



3



4



5



6



7

DATASHEET

Separate lid	600 x 400 mm
1 Pieces per pack.	📦 1
Pieces per pallet / dimens.	📦 176 / 1200x800x870H mm
Hinged lid	600 x 400 mm
2 Pieces per pack.	📦 1
Pieces per pallet / dtmens.	📦 176 / 1200x800x870H mm
2-parts lid	600 x 400 mm
3 Pieces per pack.	📦 1
Pieces per pallet / dimens.	📦 176 / 1200x800x870H mm
Cover	600 x 400 mm
4 Pieces per pack.	📦 1
Pieces per pallet / dimens.	📦 176 / 1200x800x870H mm
Disposable security seal	
5 Pieces per pack	📦 500
Pair closing clips	
6 Pieces per pack	📦 10
Label holders	
7 Pieces per pack	📦 10

	ARTICLE	WALLS			BOTTOM			HANDLES		GR.	PACKAGING		UNIT PRICE €
		Closed	Perforated	Picking short side	Closed	Perforated	Reinforced	Closed	Open		Qty. per pack.	Qty. per pallet	
	S NX 6427S 5101	■			■	■		■		2394	2	32	
	U NX 6427U 5101			■	■			■		2056	2	32	
	ARTICLE ON REQUEST												
	S NX 6427S 5401	■			■	■		■		2502	2	32	
	U NX 6427U 5401			■	■			■		2149	2	32	

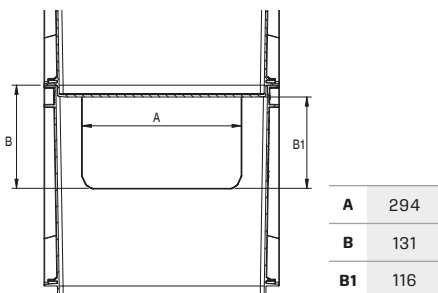
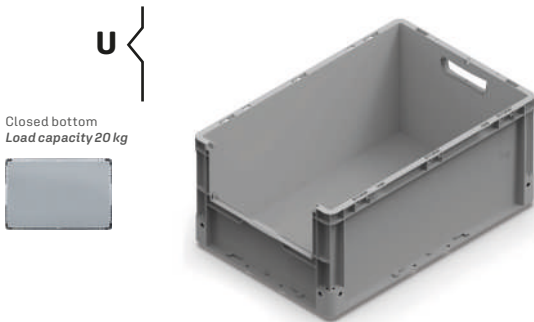
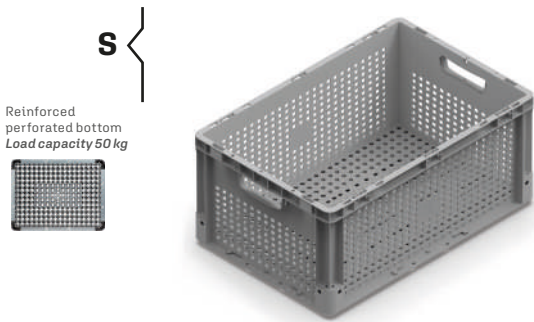

S	
Stacked edge height	255 mm
Usable stacked height / with lid	240 mm / 244 mm
Usable internal dimensions	561 x 361 x 255 H mm
Volume	52 L
Pieces per package / pallet	2 32
Package dimensions	620 x 420 x 560 H mm
Pallet dimensions	1200 x 800 x 2205 H mm
U	
Stacked edge height	255 mm
Usable stacked height / with lid	252 mm / 256 mm
Usable internal dimensions	561 x 361 x 267 H mm
Volume	54,8 L
Pieces per package / pallet	2 32
Package dimensions	620 x 420 x 560 H mm
Pallet dimensions	1200 x 800 x 2205 H mm

DATASHEET

« CONTINUED ON PREVIOUS PAGE

iMilani srl reserves the right to alter the characteristics of products without notice. The values shown are nominal, with a +/- 1% tolerance for size, depending on the material, and a +/- 3% for weight.

ARTICLES ON REQUEST

Minimum order.....200 boxes
Guaranteed shipping within.....60 days

600 x 400 mm

iMICUBE

	ARTICLE	SEPARATE LID	HINGED LID	2 PARTS LID	GR.	PACKAGING		UNIT PRICE €	
						Qty. per pack.	Qty. per pallet		
1	NX 64SE 5101	■			751	1	176		
	NX 64SE 5401	■			785	1	176	ECOGREEN ✓	
2	NX 64HG 5101		■		710	1	176		
	NX 64HG 5401		■		742	1	176	ECOGREEN ✓	
3	NX 64CR 5101			■	1016	1	176		
	NX 64CR 5401			■	1062	1	176	ECOGREEN ✓	
4	NX 64CV 5101	Cover			845	1	176		
	NX 64CV 5401				883	1	176	ECOGREEN ✓	
5	NX SEAL46 5113			2 x			500		
6	AT LOCK 8113		2 x				10		
7	LH TYT	Label holders for all sides					10		
8	NX WC64276896	Door for H270					1		



1



2

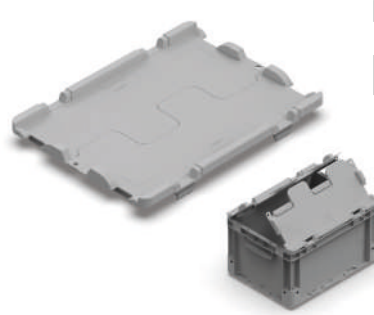

3



4



5



6



7



8

DATASHEET

Separate lid	600 x 400 mm
1 Pieces per pack.	1
Pieces per pallet / dims.	176 / 1200x800x870H mm
Hinged lid	600 x 400 mm
2 Pieces per pack.	1
Pieces per pallet / dims.	176 / 1200x800x870H mm
2-parts lid	600 x 400 mm
3 Pieces per pack.	1
Pieces per pallet / dims.	176 / 1200x800x870H mm
Cover	600 x 400 mm
4 Pieces per pack.	1
Pieces per pallet / dims.	176 / 1200x800x870H mm
Disposable security seal	
5 Pieces per pack	500
Pair closing clips	
6 Pieces per pack	10
Label holders	
7 Pieces per pack	10
Door for H270	
8 Pieces per pack	1

iMilani srl reserves the right to alter the characteristics of products without notice. The values shown are nominal, with a +/- 1% tolerance for size, depending on the material, and a +/- 3% for weight.

	ARTICLE	WALLS		BOTTOM			HANDLES		GR.	PACKAGING		UNIT PRICE €
		Closed	Perforated	Closed	Perforated	Reinforced	Closed	Open		Qty. per pack.	Qty. per pallet	
♻️ ECOGREEN	B NX 6432B 5101	■		■				■	2423	3	40	
	B NX 6432B 5401	■		■				■	2532	3	40	
♻️ PP	D NX 6432D 5101	■				■		■	2944	3	40	
⚠️	ARTICLE ON REQUEST											
♻️ ECOGREEN	D NX 6432D 5401	■				■	■		3076	3	40	

B

Closed bottom
Load capacity 20 kg



D

Reinforced bottom
Load capacity 50 kg



B

Stacked edge height	305 mm
Usable stacked height / with lid	302 mm / 306 mm
Usable internal dimensions	561 x 361 x 317 H mm
Volume	65,1 L
Pieces per package / pallet	📦 3 🚚 40
Package dimensions	620 x 420 x 675 H mm
Pallet dimensions	1200 x 800 x 2390 H mm

D

Stacked edge height	305 mm
Usable stacked height / with lid	290 mm / 294 mm
Usable internal dimensions	561 x 361 x 305 H mm
Volume	62,2 L
Pieces per package / pallet	📦 3 🚚 40
Package dimensions	620 x 420 x 675 H mm
Pallet dimensions	1200 x 800 x 2390 H mm

DATASHEET

CONTINUED ON NEXT PAGE



iMilani srl reserves the right to alter the characteristics of products without notice. The values shown are nominal, with a +/- 1% tolerance for size, depending on the material, and a +/- 3% for weight.

⚠️ ARTICLES ON REQUEST

Minimum order.....200 boxes
Guaranteed shipping within.....60 days

	ARTICLE	SEPARATE LID	HINGED LID	2 PARTS LID	GR.	PACKAGING		UNIT PRICE €	
						Qty. per pack.	Qty. per pallet		
1	NX 64SE 5101	■			751	1	176		
	NX 64SE 5401	■			785	1	176	ECOGREEN ✓	
2	NX 64HG 5101		■		710	1	176		
	NX 64HG 5401		■		742	1	176	ECOGREEN ✓	
3	NX 64CR 5101			■	1016	1	176		
	NX 64CR 5401			■	1062	1	176	ECOGREEN ✓	
4	NX 64CV 5101	Cover			845	1	176		
	NX 64CV 5401				883	1	176	ECOGREEN ✓	
5	NX SEAL46 5113			2 x		500			
6	AT LOCK 8113		2 x			10			
7	LH TYT	Label holders for all sides				10			



1



2



3



4



5



6



7

DATASHEET

Separate lid	600 x 400 mm
1 Pieces per pack.	1
Pieces per pallet / dimens.	176 / 1200x800x870H mm
Hinged lid	600 x 400 mm
2 Pieces per pack.	1
Pieces per pallet / dtmens.	176 / 1200x800x870H mm
2-parts lid	600 x 400 mm
3 Pieces per pack.	1
Pieces per pallet / dimens.	176 / 1200x800x870H mm
Cover	600 x 400 mm
4 Pieces per pack.	1
Pieces per pallet / dimens.	176 / 1200x800x870H mm
Disposable security seal	
5 Pieces per pack	500
Pair closing clips	
6 Pieces per pack	10
Label holders	
7 Pieces per pack	10

	ARTICLE	WALLS			BOTTOM			HANDLES		GR.	PACKAGING		UNIT PRICE €
		Closed	Perforated	Picking short side	Closed	Perforated	Reinforced	Closed	Open		Qty. per pack.	Qty. per pallet	
	S NX 6432S 5101	■				■	■	■		2655	3	40	
	U NX 6432U 5101			■	■				■	2323	3	40	
	ARTICLE ON REQUEST												
	S NX 6432S 5401	■				■	■	■		2774	3	40	
	U NX 6432U 5401			■	■				■	2428	3	40	

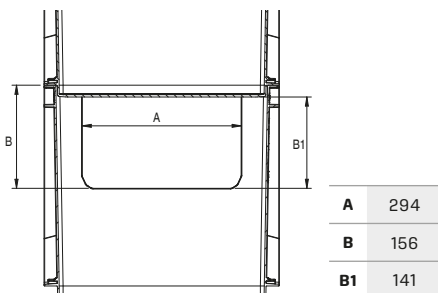
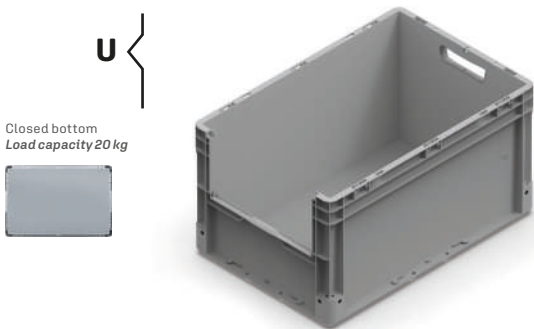
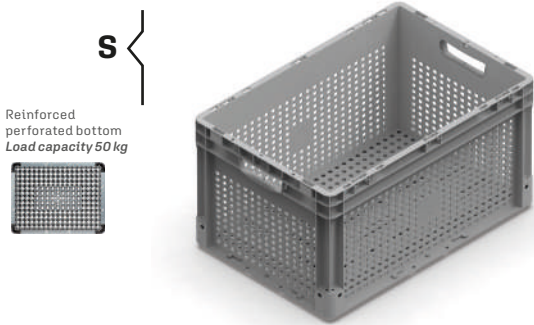

S	
Stacked edge height	305 mm
Usable stacked height / with lid	290 mm / 294 mm
Usable internal dimensions	561 x 361 x 305 H mm
Volume	62,2 L
Pieces per package / pallet	3 40
Package dimensions	620 x 420 x 675 H mm
Pallet dimensions	1200 x 800 x 2390 H mm
U	
Stacked edge height	305 mm
Usable stacked height / with lid	302 mm / 306 mm
Usable internal dimensions	561 x 361 x 317 H mm
Volume	65,1 L
Pieces per package / pallet	3 40
Package dimensions	620 x 420 x 675 H mm
Pallet dimensions	1200 x 800 x 2390 H mm

DATASHEET

« CONTINUED ON PREVIOUS PAGE









iMilani srl reserves the right to alter the characteristics of products without notice. The values shown are nominal, with a +/- 1% tolerance for size, depending on the material, and a +/- 3% for weight.

ARTICLES ON REQUEST

Minimum order.....200 boxes
Guaranteed shipping within.....60 days

600 x 400 mm

iMICUBE

	ARTICLE	SEPARATE LID	HINGED LID	2 PARTS LID	GR.	PACKAGING		UNIT PRICE €	
						Qty. per pack.	Qty. per pallet		
1	NX 64SE 5101	■			751	1	176		
	NX 64SE 5401	■			785	1	176	ECOGREEN ✓	
2	NX 64HG 5101		■		710	1	176		
	NX 64HG 5401		■		742	1	176	ECOGREEN ✓	
3	NX 64CR 5101			■	1016	1	176		
	NX 64CR 5401			■	1062	1	176	ECOGREEN ✓	
4	NX 64CV 5101	Cover			845	1	176		
	NX 64CV 5401	Cover			883	1	176	ECOGREEN ✓	
5	NX SEAL46 5113			2 x			500		
6	AT LOCK 8113		2 x				10		
7	LH TYT	Label holders for all sides					10		
8	NX WC64326896	Door for H 320					1		



1



2

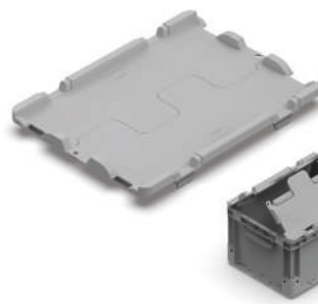

3



4



5



6















7



8

DATASHEET

Separate lid	600 x 400 mm
1 Pieces per pack.	 1
Pieces per pallet / dims.	 176 / 1200x800x870H mm
Hinged lid	600 x 400 mm
2 Pieces per pack.	 1
Pieces per pallet / dims.	 176 / 1200x800x870H mm
2-parts lid	600 x 400 mm
3 Pieces per pack.	 1
Pieces per pallet / dims.	 176 / 1200x800x870H mm
Cover	600 x 400 mm
4 Pieces per pack.	 1
Pieces per pallet / dims.	 176 / 1200x800x870H mm
Disposable security seal	
5 Pieces per pack	 500
Pair closing clips	
6 Pieces per pack	 10
Label holders	
7 Pieces per pack	 10
Door for H 320	
8 Pieces per pack	 1

iMilani srl reserves the right to alter the characteristics of products without notice. The values shown are nominal, with a +/- 1% tolerance for size, depending on the material, and a +/- 3% for weight.

	ARTICLE	WALLS		BOTTOM			HANDLES		GR.	PACKAGING		UNIT PRICE €
		Closed	Perforated	Closed	Perforated	Reinforced	Closed	Open		Qty. per pack.	Qty. per pallet	
♻️ ECOGREEN	B NX 6442B 5101	■		■			■		2886	1	20	
	B NX 6442B 5401	■		■			■		3016	1	20	
♻️ PP	D NX 6442D 5101	■				■		■	3407	1	20	
⚠️	ARTICLE ON REQUEST											
♻️ ECOGREEN	D NX 6442D 5401	■				■	■		3560	1	20	

B

Closed bottom
Load capacity 20 kg



D

Reinforced bottom
Load capacity 50 kg



B

Stacked edge height	405 mm
Usable stacked height / with lid	402 mm / 406 mm
Usable internal dimensions	561 x 361 x 417 H mm
Volume	85,6 L
Pieces per package / pallet	📦 1 🚚 20
Package dimensions	620 x 420 x 455 H mm
Pallet dimensions	1200 x 800 x 2190 H mm

D

Stacked edge height	405 mm
Usable stacked height / with lid	390 mm / 394 mm
Usable internal dimensions	561 x 361 x 405 H mm
Volume	82,8 L
Pieces per package / pallet	📦 1 🚚 20
Package dimensions	620 x 420 x 455 H mm
Pallet dimensions	1200 x 800 x 2190 H mm

DATASHEET







CONTINUED ON NEXT PAGE



iMilani srl reserves the right to alter the characteristics of products without notice. The values shown are nominal, with a +/- 1% tolerance for size, depending on the material, and a +/- 3% for weight.

⚠️ **ARTICLES ON REQUEST**

Minimum order.....200 boxes
Guaranteed shipping within.....60 days

	ARTICLE	SEPARATE LID	HINGED LID	2 PARTS LID	GR.	PACKAGING		UNIT PRICE €	
						Qty. per pack.	Qty. per pallet		
1	NX 64SE 5101	■			751	1	176		
	NX 64SE 5401	■			785	1	176	ECOGREEN ✓	
2	NX 64HG 5101		■		710	1	176		
	NX 64HG 5401		■		742	1	176	ECOGREEN ✓	
3	NX 64CR 5101			■	1016	1	176		
	NX 64CR 5401			■	1062	1	176	ECOGREEN ✓	
4	NX 64CV 5101	Cover			845	1	176		
	NX 64CV 5401	Cover			883	1	176	ECOGREEN ✓	
5	NX SEAL46 5113			2 x		500			
6	AT LOCK 8113		2 x			10			
7	LH TYT	Label holders for all sides				10			



1



2

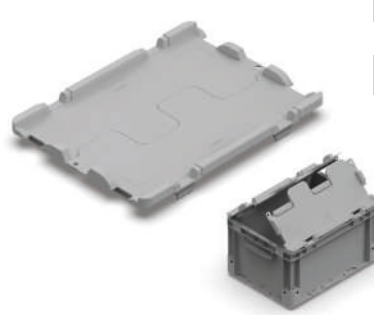

3

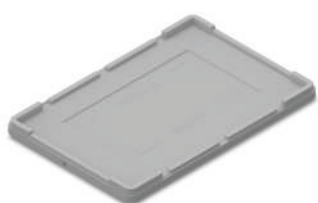

4



5



6

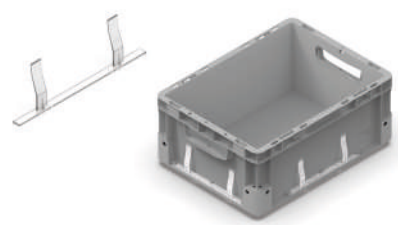

7

DATASHEET

Separate lid	600 x 400 mm
1 Pieces per pack.	📦 1
Pieces per pallet / dimens.	📦 176 / 1200x800x870H mm
Hinged lid	600 x 400 mm
2 Pieces per pack.	📦 1
Pieces per pallet / dtmens.	📦 176 / 1200x800x870H mm
2-parts lid	600 x 400 mm
3 Pieces per pack.	📦 1
Pieces per pallet / dimens.	📦 176 / 1200x800x870H mm
Cover	600 x 400 mm
4 Pieces per pack.	📦 1
Pieces per pallet / dimens.	📦 176 / 1200x800x870H mm
Disposable security seal	
5 Pieces per pack	📦 500
Pair closing clips	
6 Pieces per pack	📦 10
Label holders	
7 Pieces per pack	📦 10

	ARTICLE	WALLS			BOTTOM			HANDLES		GR.	PACKAGING		UNIT PRICE €
		Closed	Perforated	Picking short side	Closed	Perforated	Reinforced	Closed	Open		Qty. per pack.	Qty. per pallet	
	S NX 6442S 5101	■			■	■		■		3018	1	20	
	U NX 6442U 5101			■	■			■		2759	1	20	
	ARTICLE ON REQUEST												
	S NX 6442S 5401	■			■	■		■		3154	1	20	
	U NX 6442U 5401			■	■			■		2883	1	20	

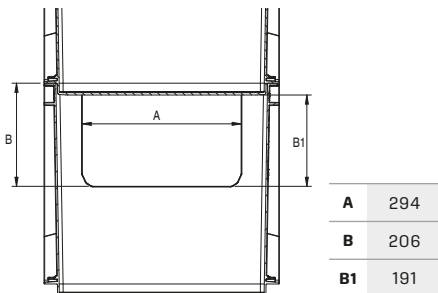
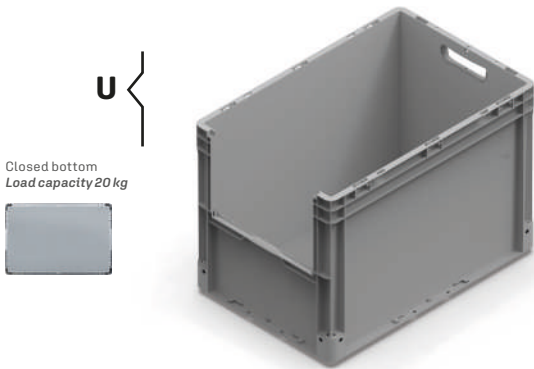
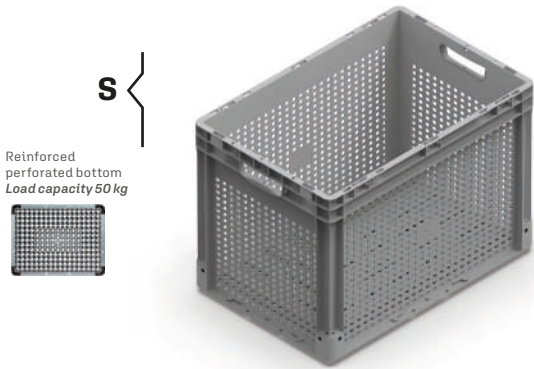

S

Stacked edge height	405 mm
Usable stacked height / with lid	390 mm / 394 mm
Usable internal dimensions	561 x 361 x 405 H mm
Volume	82,8 L
Pieces per package / pallet	1 20
Package dimensions	620 x 420 x 455 H mm
Pallet dimensions	1200 x 800 x 2190 H mm

U

Stacked edge height	405 mm
Usable stacked height / with lid	402 mm / 406 mm
Usable internal dimensions	561 x 361 x 417 H mm
Volume	85,6 L
Pieces per package / pallet	1 20
Package dimensions	620 x 420 x 455 H mm
Pallet dimensions	1200 x 800 x 2190 H mm

DATASHEET

« CONTINUED ON PREVIOUS PAGE

iMilani srl reserves the right to alter the characteristics of products without notice. The values shown are nominal, with a +/- 1% tolerance for size, depending on the material, and a +/- 3% for weight.

ARTICLES ON REQUEST

Minimum order.....200 boxes
Guaranteed shipping within.....60 days

600 x 400 mm

iMICUBE

	ARTICLE	SEPARATE LID	HINGED LID	2 PARTS LID	GR.	PACKAGING		UNIT PRICE €	
						Qty. per pack.	Qty. per pallet		
1	NX 64SE 5101	■			751	1	176		
	NX 64SE 5401	■			785	1	176	ECOGREEN ✓	
2	NX 64HG 5101		■		710	1	176		
	NX 64HG 5401		■		742	1	176	ECOGREEN ✓	
3	NX 64CR 5101			■	1016	1	176		
	NX 64CR 5401			■	1062	1	176	ECOGREEN ✓	
4	NX 64CV 5101	Cover			845	1	176		
	NX 64CV 5401				883	1	176	ECOGREEN ✓	
5	NX SEAL46 5113			2 x			500		
6	AT LOCK 8113		2 x				10		
7	LH TYT	Label holders for all sides					10		
8	NX WC64426896	Door for H 420					1		



1



2

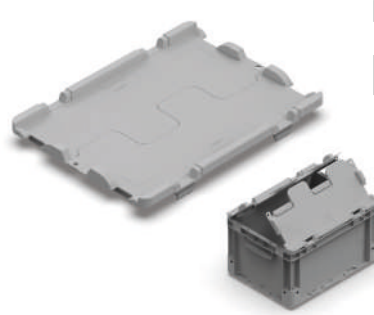

3



4



5



6



7



8

DATASHEET

Separate lid	600 x 400 mm
1 Pieces per pack.	1
Pieces per pallet / dims.	176 / 1200x800x870H mm
Hinged lid	600 x 400 mm
2 Pieces per pack.	1
Pieces per pallet / dims.	176 / 1200x800x870H mm
2-parts lid	600 x 400 mm
3 Pieces per pack.	1
Pieces per pallet / dims.	176 / 1200x800x870H mm
Cover	600 x 400 mm
4 Pieces per pack.	1
Pieces per pallet / dims.	176 / 1200x800x870H mm
Disposable security seal	
5 Pieces per pack	500
Pair closing clips	
6 Pieces per pack	10
Label holders	
7 Pieces per pack	10
Door for H 420	
8 Pieces per pack	1

iMilani srl reserves the right to alter the characteristics of products without notice. The values shown are nominal, with a +/- 1% tolerance for size, depending on the material, and a +/- 3% for weight.

600 x 400 mm

iMICUBE

NEXIT

84

1



2



3



4



5



	ARTICLE	1 SÉPARATION	2 SÉPARATIONS	4 SÉPARATIONS	GR.	EMBALLAGE		PRIX UNITAIRE €	
						Qté par paq.	Qté par palette		
ECOGREEN ✓	1 AT 64S1 5407	■			428	10	160		
ECOGREEN ✓	2 AT 64S2 5407		■		460	10	160		
ECOGREEN ✓	3 AT 64S4 5407			■	489	10	160		
ECOGREEN ✓	4 AT 64S0 5407	■			345	20	320		
	5 AT LID6 6896	Transparent lid					20		

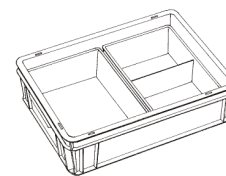

Subdivision with 1 and 2 compartments



Subdivision with 1 and 4 compartments

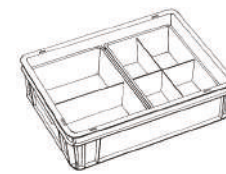

Subdivision with 2 and 4 compartments

1	Partitioned box 1 partition	357 x 278 x 90 H mm
	Pieces per pack / pallet	📦 10 🚚 160
	Package dimensions	565 x 375 x 460 H mm
	Pallet dimensions	1200 x 800 x 1990 H mm
2	Partitioned box 2 partitions	357 x 278 x 90 H mm
	Pieces per pack / pallet	📦 10 🚚 160
	Package dimensions	565 x 375 x 460 H mm
	Pallet dimensions	1200 x 800 x 1990 H mm
3	Partitioned box 4 partitions	357 x 278 x 90 H mm
	Pieces per pack / pallet	📦 10 🚚 160
	Package dimensions	565 x 375 x 460 H mm
	Pallet dimensions	1200 x 800 x 1990 H mm
4	Partitioned box 1 partition	277 x 177 x 99 H mm
	Pieces per pack / pallet	📦 20 🚚 320
	Package dimensions	565 x 375 x 460 H mm
	Pallet dimensions	1200 x 800 x 1990 H mm
5	Transparent polystyrene lid	
	Pieces per pack / pallet	📦 20
	Package dimensions	365 x 295 x 180 H mm

DATASHEET

600 x 400 mm

	ARTICLE	H 45	H 70	H 90	H 120	H 180	H 220	PACKAGING		UNIT PRICE €
								Qty. per pack.	Qty. per pallet	
1	DI 35545246801	■						10		PS
	DI 55545246801	■						10		
2	DI 35570246801		■					10		PS
	DI 55570246801		■					10		
3	DI 35590246801			■				10		PS
	DI 55590246801			■				10		
4	DI 35512246801				■			10		PS
	DI 55512246801				■			10		
5	DI 35518246801					■		10		PS
	DI 55518246801					■		10		
6	DI 35522246801						■	10		PS
	DI 55522246801						■	10		
7	DI 64SHT 5101							10		PS

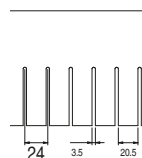

6801
Pitch 24 mm

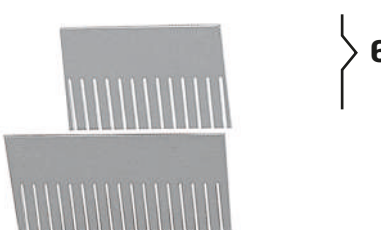
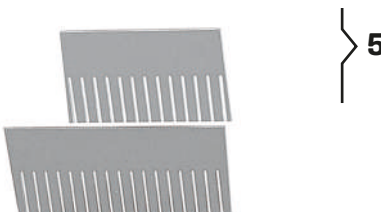
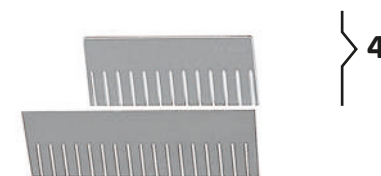
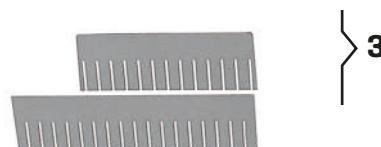
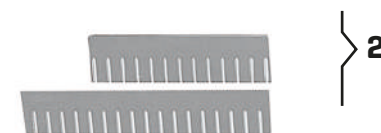

DATASHEET

1	Comb divider 355 x 45 H mm per box 600x400x75H mm	10 items
	Comb divider 555 x 45 H mm per box 600x400 x H 75 mm	10 items
2	Comb divider 355 x 70 H mm per box 600x400 x 120 H mm	10 items
	Comb divider 555 x 70 H mm per box 600x400 x 120 H mm	10 items
3	Comb divider 355 x 90 H mm per box 600x400 x 120 H mm	10 items
	Comb divider 555 x 90 H mm per box 600x400 x 120 H mm	10 items
4	Comb divider 355 x 120 H mm per box 600x400 x 170 H mm	10 items
	Comb divider 555 x 120 H mm per box 600x400 x 170 H mm	10 items
5	Comb divider 355 x 180 H mm per box 600x400 x 220 H mm	10 items
	Comb divider 555 x 180 H mm per box 600x400 x 220 H mm	10 items
6	Comb divider 355 x 220 H mm per box 600x400 x 270 H mm	10 items
	Comb divider 555 x 220 H mm per box 600x400 x 270 H mm	10 items
7	Intermediate partition shelf 555 x 355 mm	10 items